



CIP Enhancement Plus a Whole Lot More

62-174/326 Air Blow Check Valve

PD 66375 US 2002-09

Application

Alfa Laval®'s Tri-Clover® brand Air Blow Check Valve is designed to (1) evacuate lines of product or CIP solution and (2) for air agitation of product in tanks and other vessels. It also helps to protect pipelines against corrosion – air drying of lines permits formation of protective oxide film . . . the key to placing a system in its most corrosion resistant condition. Improves product uniformity and quality – product air agitation thoroughly mixes and blends product.

Standard Design

- Fail Safe Operation – backflow of product or CIP solution prevented by simple air to open, spring to close operation.
- Easy Assembly/Disassembly – Tri-Clamp® connections permit quick disassembly and assembly for replacing Filter Media, cleaning or inspection.
- Remotely Controlled – can be remotely controlled by controlling the supply of air to the valve.
- Rugged Construction – type 316 stainless steel is standard. Spherical plug assembly is bonded EPDM rubber.
- Conforms to 3A Accepted Practices – for applications requiring a final filtering of air prior to entering tank or pipelines.

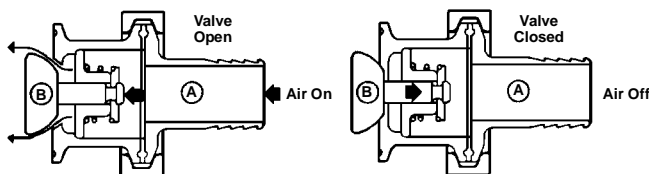
Working Principle

Filtered air enters adapter (A) and exerts pressure on the valve plug assembly (B) causing it to move forward and unseat. The filtered air passes through the valve and around the valve plug assembly (B) entering the pipeline or tank. When the air pressure entering the adapter (A) is shut-off the valve plug assembly is returned to its normally closed position by return spring, preventing any product or CIP solution backflow. The Air Blow Check Valve can be used in any position, horizontal or vertical.

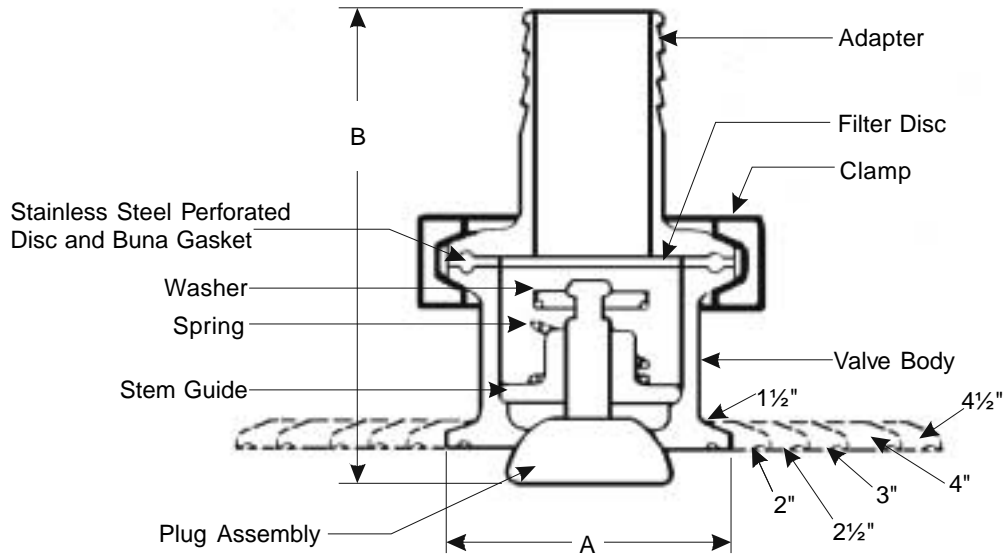


Fig. 1. 62-174 and 62-326 Air Blow Check Valves

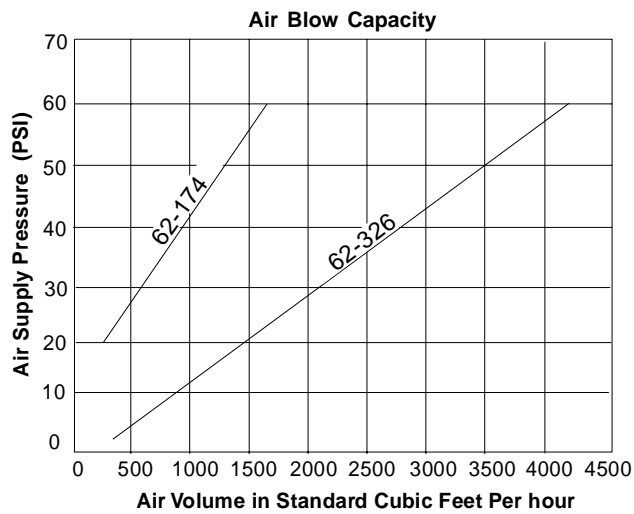
The Air Blow Check Valve is easily installed on tanks or other vessels, for product agitation, by using a Tri-Clamp, a gasket, and a mounting ferrule. No other fittings are required. To use the Air Blow Check valve to evacuate lines of product or CIP solution it is recommended that it be clamped on the end of the "Y" branch of a Ball Check Valve then installed in the line. See page 3 for illustrations of typical installations.






Dimensions (inches)




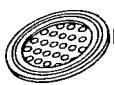
| Connection Size | A-OD (inches) | B-Overall Length | | | | | |
|-----------------|---------------------------------|------------------|-------------|---------------------|---------------------------------|--------------------------------|---------------------------------|
| | | Model 62-174R | | | Model 62-326-Adapter-Size | | |
| | | "A" Adapter | "B" Adapter | "C" or "C1" Adapter | "A" Adapter | "B" Adapter | "C" Adapter |
| 1 1/2 | 1 ¹⁵ / ₁₆ | 2 1/2 | 3 | 2 | 3 ¹¹ / ₁₆ | 3 ⁹ / ₁₆ | 2 ¹¹ / ₁₆ |
| 2 | 2 1/2 | 2 1/2 | 3 | 2 | 3 ¹¹ / ₁₆ | 3 ⁹ / ₁₆ | 2 ¹¹ / ₁₆ |
| 2 1/2 | 2 ¹ / ₁₆ | 2 1/2 | 3 | 2 | 3 ¹¹ / ₁₆ | 3 ⁹ / ₁₆ | 2 ¹¹ / ₁₆ |
| 3 | 3 ⁹ / ₁₆ | 2 1/2 | 3 | 2 | 3 ¹¹ / ₁₆ | 3 ⁹ / ₁₆ | 2 ¹¹ / ₁₆ |
| 4 | 4 ¹¹ / ₁₆ | 2 1/2 | 3 | 2 | 3 ¹¹ / ₁₆ | 3 ⁹ / ₁₆ | 2 ¹¹ / ₁₆ |
| 4 1/2 | 5 ¹ / ₈ | 2 1/2 | 3 | 2 | 3 ¹¹ / ₁₆ | 3 ⁹ / ₁₆ | 2 ¹¹ / ₁₆ |



Variety of Adapters Available

| Adapter Type | For Model 62-174R | For Model 62-326 |
|---|---|--|
|  <p>"A" Adapter - For Air Line Quick Coupler</p> | (A) #37-80 | (A) #37-161 |
|  <p>"B" Adapter - For 1" ID Rubber Hose</p> | (B) #14MPHR-1-S | (B) #14MPHR-2 x 1-S |
|  <p>"C" Adapter - For NPT Female Connector "C1" Adapter</p> | (C) #23BMP-1½ x ¾-S ¾ NPT Female Connection (C1) #23BMP-1½ x ½-S ½ NPT Female Connection | (C) #23BMP-2 x ¾-S ¾ NPT Female Connection |

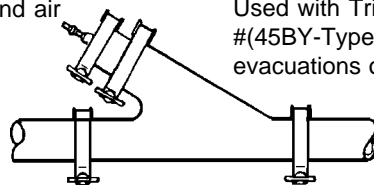
Replacement Media Ordering Information

| Item | For Model 62-174R | For Model 62-326 |
|---|---|--|
|  <p>Filter Disc (fits all sizes)</p> | Order #FA-1½-30C Sold 50/pkg. .3 MICRON | Order #FA-2-30C Sold 50/pkg. .3 MICRON |
|  <p>SS Perforated Disc and Buna Gasket</p> | Order #FAD-1½-01 Sold in Single Units | Order #FAD-2-01 Sold in Single Units |

Note: The Air Blow Check Valve must be used with a Filter Disc (Not furnished with unit). These filter discs are available in packages of 50.

Typical Installations of Air Blow Check Valve and Disposable Air Filter Media

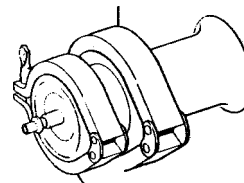
(62-156A-SIZE)
includes 45BY and air
blow assembly



For Air Blowing Pipelines -

Used with Tri-Clover's ball check valve #45BY-Type Connection-Size) for pipeline evacuations of product or C.I.P solution.

**For Product Agitation
in Tank or Vessels**



Technical Data

Pressure range Varies based on style of clamp used. Contact Alfa Laval.
Temperature range 20°F to 284°F
Air pressure 8-10 PSI minimum

Materials

Product wetted steel parts AISI 316 stainless steel
Other steel parts AISI 304 stainless steel
Product wetted parts EPDM
Other seals Buna

Options

- SFY molded elastomers
- Air fittings - Air quick coupler
Hose barb
NPT tapped hole

Ordering

Please state the following when ordering:

- 62-174 (low volume)
- 62-326 (high volume)
- Tri-Clamp mounting connection size
- Type of air connection