



ITT

Pure-Flo®

How to Order



Engineered for life

www.ittpureflo.com

This brochure contains a comprehensive list of the figure number codes and description for each valve product option available at Pure-Flo Solutions Group. To assist in the ordering process, we have included instructions on how to construct a standard valve figure number in proper sequence. You can also find our valve configuration tool available at www.ittpureflo.com. This Microsoft Excel tool is a simple means of identifying valve product configuration and nomenclature. This tool will assist in selecting compatible features and proper designation structure.

Table of Contents

Introduction	2
Valve Configurator Tool	3
How to Construct a Standard Valve Figure Number	4
Bodies and Polishes	5
Diaphragms	6
Manual Bonnets, Actuator Bonnets and Options	7
Actuator Options	8
Switches and Actuator Accessories	9-10
Service Preparation and Quality Documents	11
Obsolete Figure Codes	12
Sterile Access and GMP Fabrications	13-14
Zero Static Fabrications	15-17
Multiport Valves	18-19
Terms & Conditions	20-21
Office Locations	22

Pure-Flo® Microsoft Excel Valve Configurator Tool

To assist you in the specification development and ordering process we have a Microsoft Excel tool available at www.ittpureflo.com that will help you:

- select compatible valve features
- create correct figure numbers

To access the tool:

1. Hold your mouse over the Tools button and click on "Valve Configurator" from the dropdown list
2. Request a username and password if you do not already have one
3. Once registered, login with your username and password
4. After you have logged in, download the valve configurator tool

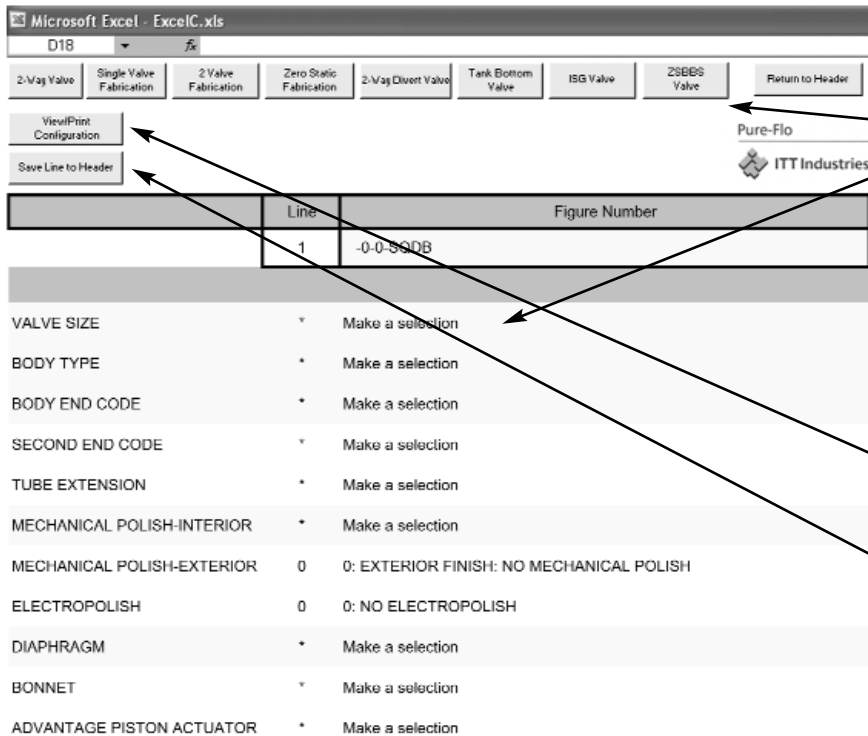

To create figure numbers follow these steps:

1. Select valve type
2. Make feature selections
3. Continue making selections until no sections remain in yellow
4. Cells highlighted in red will explain cases where the selection of one feature requires the selection of another feature (ex. "963" bonnet requires "M2" bonnet internals)
5. Click "View/Print" to see the resulting figure number with descriptions
6. Click "Save Line to Header" to save the figure number configuration
7. Repeat steps 1-6 until you have all the figure numbers required

Line	Figure Number
0	1-F-419-2-0-0-TM17-913-SQDB
	SIZE:1"(DN25) F: FORGED 316L SS 419: TRICLAMP TUBE 2: INTERIOR FINISH: RA 35 MICROINCH MAX 0: EXTERIOR FINISH: NO MECHANICAL POLISH 0: NO ELECTROPOLISH TM17: DIAPHRAGM:MODIFIED PTFE(FDA)/GRADE 17 B.C. 913: BONNET:SS/HWO/TRAVEL STOP SQDB: C OF C BODY CMTR FIG_NO-1-F-419-2-0-0-TM17-913-SQDB

Resulting figure number with description

Please contact your local Pure-Flo sales representative or Distributor for a demonstration or for assistance using the Microsoft Excel Valve Configuration tool.

Pure-Flo Valve Figure Numbers

How to Construct a Standard Valve Figure Number

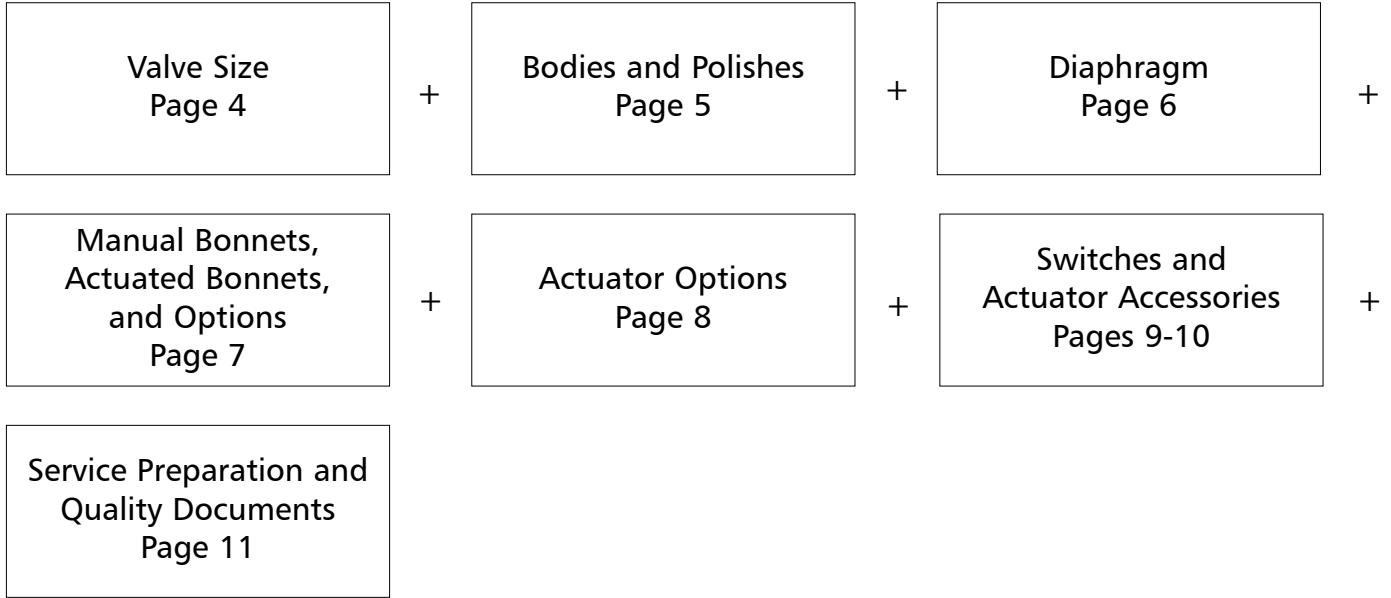

Constructing Figure Numbers

Below are examples for constructing a manual and actuated valve figure number. The actuated valve example will be used to build a figure number on pages 4-11.

Manual Valve Example

Figure Number: 1-F-419-6-0-0-TM17-963-M2-SQDB

Detailed description:

1: 1 inch size (DN25)
 F: Forged 316L SS
 419: Triclamp Tube
 6: Interior Finish: Ra 25 Microinch Max
 0: Exterior Finish: No Mechanical Polish
 0: No Electropolish
 TM17: Modified PTFE Diaphragm (FDA)/ Grade 17 B.C.
 963: Plastic PAS Rising Handwheel with Travel Stop
 M2: Sanitary Internals
 SQDB: C of C Body CMTR

Actuated Valve Example

Figure Number: 1-F-428L-6-0-0-TM17-36-M7-A209-VSPS48-SQDB

Detailed description:

1: 1 inch size (DN25)
 F: Forged 316L SS
 428L: 16 Gauge Extended Tangent Butt weld
 6: Interior Finish: Ra 25 Microinch Max
 0: Exterior Finish: No Mechanical Polish
 0: No Electropolish
 TM17: Modified PTFE Diaphragm (FDA)/ Grade 17 B.C.
 36: Plastic/PAS Actuated Bonnet
 M7: Bronze Compressor
 A209: Advantage Actuator, #209 Rev/ 90# Spring
 VSPS48: Value Switch Package, Silver Contacts 48V
 SQDB: C of C Body CMTR

Valve Size

Size

Code	Description
.25	.25 Inch (DN6)
.38	.38 Inch (DN10)
.50	.50 Inch (DN15)
.75	.75 Inch (DN20)
1	1 Inch (DN25)
1.5	1.5 Inch (DN40)
2	2 Inch (DN50)
2.5	2.5 Inch (DN65)
3	3 Inch (DN80)
4	4 Inch (DN100)

Figure Number: 1-

Configuration Example	1
Size (in)	1

Body Type

Code	Description
2	Industrial Valve Body - Cast CF3M Stainless Steel
8	Bio-Tek® Forged 316L Stainless Steel
C	Cast CF3M Stainless Steel
F	Forged 316L Stainless Steel
N	Body Not Supplied
S	Swickle Body Cast CF3M Stn. Stl.
TBV	Tank Bottom Valve
TBVCR	Tank Bottom Valve 316L BN2
W	Wrought 316L Stainless Steel
Spec	Special Material Body

Body Ends

Code	Description
CLAMP	
409	Swagelok TS Fitting
410	Tri-Clamp Sch. 5 Pipe
411	Min. Valine
412	S Clamp
413	Q Clamp
414	I Line-Male
415	I Line-Female
416	Swivel Nut
417	Male Thread
418	ISO 1.6mm Wall Tri-Clamp End
419	Tri-Clamp Tube
419S	Tri-Clamp Tube 18 Gauge
419S1	Tri-Clamp Tube 20 Gauge
420	Superior
BUTTWELD	
422	Sch. 5 Pipe (ISO Body)
423	18 Gauge
424	20 Gauge
425	Sch. 5 Pipe (ANSI Body)
426	Sch. 10 Pipe
427	Sch. 40 Pipe
428	16 Gauge
428L	16 Gauge Extended Tangent BW
429	14 Gauge
429L	14 Gauge Extended Tangent BW
430	12 Gauge BW
433	ANSI Flanged
475	6X1 Mini Fitting BW
476	8X1 Mini Fitting BW
477	10X1 Mini Fitting BW
478	12X1 Mini Fitting BW
479	18X1 Mini Fitting BW
480	14X1 Mini Fitting BW
481	DIN Series 1
482	DIN Series 2
483	DIN Series 3
484	SMS
485	TBV, 45 Degree 14 GA BW
486	TBV, 45 Degree 16 GA BW
487	TBV, 45 Degree 18 GA BW
488	TBV, 45 Degree Tri-Clamp
493	ISO 2.9mm wall
494	ISO 1.2mm wall

Body Ends (cont.)

Code	Description
495	ISO 1.0mm wall
496	ISO 1.6mm wall
497	ISO 2.0mm wall
498	ISO 2.3mm wall
499	ISO 2.6mm wall
Spec	Special End
SCREWED	
403	NPT Screwed
FLANGED	
433R	ANSI Flanged w/ Raised Face

Second End Code

Code	Description
CLAMP	
X07	By Male Thread w/ Gasket Seat
X09	Swagelok TS Fitting
X10	By Tri-Clamp Sch. 5 Pipe
X11	By Min. Valine
X12	By S Clamp
X13	By Q Clamp
X14	By I Line - Male
X15	By I line - Female
X17	By Male Thread
X19	By Tri-Clamp Tube
X19S	By Tri-Clamp Tube 18 Gauge
X19S1	By Tri-Clamp Tube 20 Gauge
X20	By Superior
BUTTWELD	
X22	By Sch. 5 Pipe (ISO Body)
X23	By 18 Gauge
X24	By 20 Gauge
X25	By Sch. 5 Pipe (ANSI Body)
X26	By Sch. 10 Pipe
X27	By Sch. 40 Pipe
X28	By 16 Gauge
X28L	By 16 Gauge Extended Tangent BW
X29	By 14 Gauge
X29L	By 14 Gauge Extended Tangent BW
X30	By 12 Gauge BW
X75	By 6X1 Mini Fitting BW
X76	By 8X1 Mini Fitting BW
X77	By 10X1 Mini Fitting BW
X78	By 12X1 Mini Fitting BW
X79	By 18X1 Mini Fitting BW
X80	By 14X1 Mini Fitting BW
X81	By DIN Series 1
X82	By DIN Series 2
X83	By DIN Series 3
X84	By SMS
X85	By ISO
X93	By ISO 2.9mm Wall
X94	By ISO 1.2mm Wall
X95	By ISO 1.0mm Wall
X96	By ISO 1.6mm Wall
X97	By ISO 2.0mm Wall
X98	By ISO 2.3mm Wall
X99	By ISO 2.6mm Wall
Spec	Special End

Tube Extension

Code	Description
TE1	Valve End 1
TE2	Valve End 2
TEA	Both Valve Ends & Purge End
TEB	Both Valve Ends
TEP	Purge End
TE1P	Valve End (P1) & Purge (P3)
TE2P	Valve End (P2) & Purge (P3)

Mechanical Polish - Interior

Code	Description
0	As Cast
2	35 µin Ra (.8 µm) max
6	25 µin Ra (.6 µm) max
7	15 µin Ra (.38 µm) max
8	20 µin Ra (.5 µm) max
9	11 µin Ra (.28 µm) max
10	10 µin Ra (.25 µm) max
SFV1	BPE SFV1 Ra 20 Max
SFV2	BPE SFV1 Ra 25 Max
SFV3	BPE SFV1 Ra 30 Max
SFV4	BPE SFV1 Ra 15 Max, EP
SFV5	BPE SFV1 Ra 20 Max, EP
SFV6	BPE SFV1 Ra 25 Max, EP

Mechanical Polish -Exterior

Code	Description
0	As Cast
1	Scotch Brite
2	25 µin Ra (.6 µm) max, Welds Scotch Brite
3	35 µin Ra (.8 µm) max, Welds Scotch Brite
4	25 µin Ra (.6 µm) max, Welds Removed
6	35 µin Ra (.8 µm) max, Welds Removed
7	Special Polish Requirement
8	No Ext Body Polish, Weld Beads Removed

Electropolish

Code	Description
0	No Electropolish
2	Exterior Only
3	Interior and Exterior
4	Interior Only

Body Only

Code	Description
Y	Body Only Supplied

Figure Numer: 1-F-428L-6-0-0-

Configuration Example		F	428L			6	0	0	
Bodies and Polishes	Body Type	F							
	Body Ends		428L						
	Second End Code								
	Tube Extension								
	Mechanical Polish - Interior					6			
	Mechanical Polish - Exterior							0	
	Electropolish								0
	Body Only								

Pure-Flo Valve Figure Numbers

Diaphragms

Diaphragms

Code	Material
B	Black Butyl (FDA)
17	EPDM Compound 17 (FDA)
B17	Biotek EPDM Compound 17
EN	Elastomer Not Supplied
M	EPDM (non-FDA)
P	BUNA - N (FDA)
PN	PTFE Not Supplied
R2	PTFE (FDA)
TM17	PTFE (FDA)/Grade 17 BC
V	Viton
W1	White Butyl (FDA)

Figure Numer: 1-F-428L-6-0-0-TM17-

Configuration Example	TM17
Diaphragms	TM17

Pure-Flo Valve Figure Numbers

Manual Bonnets, Actuator Bonnets and Options

Manual Bonnets

Code	Bonnet Description
BIO-TEK®	
18	Standard Bonnet, Non-Sealed
18S	Standard Bonnet, Sealed

CAST IRON

903	Rising Stem with Travel Stop
903S	Rising Stem with Travel Stop - Sealed

STAINLESS STEEL (316)

913	Rising Stem with Travel Stop
913S	Rising Stem with Travel Stop - Sealed
915	CH WHL with Travel Stop
915S	CH WHL with Travel Stop - Sealed
970	Rising Handwheel with Travel Stop

PLASTIC PAS*

963	Rising Handwheel with Travel Stop (1/2" - 4")
963S	Rising Handwheel with Travel Stop - Sealed (1/2" - 4")

*NA-2.5" Casting

Actuated Bonnets

Code	Description
------	-------------

CAST IRON

40	Direct Load
----	-------------

STAINLESS STEEL

31	Actuated
31S	Actuated - Sealed

DUCTILE IRON

34	Actuated
34S	Actuated - Sealed
84	Dualrange
84S	Dualrange Sealed

PLASTIC PAS*

36	Actuated
36S	Actuated - Sealed

*NA-2.5" Casting

Weep Holes

Code	Description
W2	Two Weep Holes in Bonnet
W4	Four Weep Holes in Bonnet (3A Internals Only)

Electropolish Topworks

Code	Description
1	Topworks
1S	Advantage Spool

Optional Coatings

Code	Description
C1	PVDF Coated Topworks
C4	White Epoxy Coated Topworks
C7	Nylon Coated Topworks
CSpec	Coating Specified

Bonnet Seal Materials

Code	Description
S1	EPDM
S2	Viton

Optional Bonnet Internals

Code	Description
M2	Sanitary Internals
M3	3A Sanitary Internals
M5	Stainless Steel Stem
M6	Cast Iron Compressor
M7	Bronze Compressor
M8	PVDF Coated Cast Iron Compressor
M9	Stainless Steel Bushing
M10	Stainless Steel Tube Nut
M17	PPS Cap
M18	Heat Shrink Tubing on Handwheel

Optional Body/Bonnet Bolting

Code	Description
B8	Stainless Steel ASTM A193 B8
BLTS	MNT HDWR, Except STDS, Supplied w/o Body
BSpec	Special Bonnet Flange Bolting
MET	Metric Bonnet Flange Fasteners

Yoke

Code	Description
Y	Yoke Supplied

Locking Device

Code	Description
LD	Locking Device

Extended Stem

Code	Description
EXTSTEM	Extended Stem
EXTSTEMR	Extended Stem from Valve CL to Top of Rim
EXTSTEMC	Extended Stem from Valve CL to Indicator Cap
LCAP	Stem Ext. from Center of Valve to Top of Cap
LRIM	Stem Ext from Center of Valve to Top of Rim

Figure Numer: 1-F-428L-6-0-0-TM17-36-M7-

Configuration Example		36	M7
Manual Bonnets & Accessories	Manual Bonnets		
	Actuated Bonnets	36	
	Weep Holes		
	Electropolish Topworks		
	Optional Coatings		
	Bonnet Seal Materials		M7
	Optional Bonnet Internals*		
	Optional Body/Bonnet Bolting		
	Yoke		
	Locking Device		
	Extended Stem		

*Multiple selections allowed

Pure-Flo Valve Figure Numbers

Actuator Options

Advantage Actuators

Code	Actuator
DIRECT ACTING	
A103	# 3 (Bio-Tek®)
A105	# 5
A108	# 8
A116	# 16
A133	# 33
A147	# 47
REVERSE ACTING	
A203	# 3 with 60# Spring (Bio-Tek®)
A204	# 3 with 90# Spring (Bio-Tek®)
A205	# 5 with 60# Spring
A206	# 5 with 90# Spring
A208	# 8 with 60# Spring
A209	# 8 with 90# Spring
A216	# 16 with 60# Spring
A217	# 16 with 90# Spring
A233	# 33 with 60# Spring
A234	# 34 with 90# Spring
A247	# 47 with 60# Spring
A248	# 47 with 80# Spring
DOUBLE ACTING	
A303	# 3 (Bio-Tek®)
A305	# 5
A308	# 8
A316	# 16
A333	# 33
A347	# 47

APA Advantage Piston Actuator

Code	Description
APBT6	Bio-Tek® with 60# spring
APT89	Bio-Tek® with 90# spring
AP0506	0.50" with 60# spring
AP0509	0.50" with 90# spring
AP0756	0.75" with 60# spring
AP0759	0.75" with 90# spring
AP1006	1.0" with 60# spring
AP1009	1.0" with 90# spring
AP1506	1.5" with 60# spring
AP1509	1.5" with 90# spring
AP2006	2.0" with 60# spring
AP2009	2.0" with 90# spring

Dia-Flo Actuators

Code	Actuator Size
DIRECT ACTING ACTUATORS, NORMALLY OPEN (SPRING TO OPEN-AIR TO CLOSE)	
3112	#12
3125	#25
3126	#25 for Vacuum Service
3150	#50
31101	#101
31130	#130
31250	#250
REVERSE ACTING ACTUATORS, NORMALLY CLOSED (AIR TO OPEN-SPRING TO CLOSE)	
SIZE #12	
3213	88 Spring
3214	88 & 89 Springs
3215	88 & Raymond Springs
3216	89 Spring
SIZE #25	
3226	101 Spring
3227	101 & 102A Springs
3228	102A Spring
SIZE #50	
3251	101 Spring
3252	101 & 102A Springs
3253	97 Spring
3254	96 Spring
3255	96 & 97 Springs
3256	102A Spring
SIZE #75	
3274	96 Spring
3276	96 & 97 Springs
3277	97 & 98 Springs
3278	96 & 98 Springs
3279	96, 97 & 98 Springs
SIZE #101	
32102	96 Spring
32103	98 Spring
32104	96 & 97 Springs
32105	96 & 98 Springs
32106	97 & 98 Springs
32107	96, 97, & 98 Springs
32108	130 Spring
32109	97 Spring

Dia-Flo Actuators

Code	Actuator Size
DOUBLE ACTING ACTUATORS (AIR TO OPEN-AIR TO CLOSE)	
SIZE #130	
32131	97 Spring
32132	96 Spring
32133	98 Spring
32134	96 & 97 Springs
32135	96 & 98 Springs
32136	97 & 98 Springs
32137	96, 97, & 98 Springs
32138	130 Spring
SIZE #250	
32251	129 & 130 Springs
32252	129 Spring
32253	130 Spring
3312	#12 Double Acting
3325	#25 Double Acting
3350	#50 Double Acting
3375	#75 Double Acting
33101	#101 Double Acting
33130	#130 Double Acting
33250	#250 Double Acting

Non ITT Actuation

Code	Description
POF	Customer Supplied Actuator
POM	With Non-ITT Actuator

Figure Number: 1-F-428L-6-0-0-TM17-36-M7-A209-

Configuration Example		A209
Actuator Options	Actuator Options (select 1):	A209
	Advantage Actuator	
	APA Advantage Piston Actuator	
	Dia-Flo Actuators	
	Non ITT Actuation	

Pure-Flo Valve Figure Numbers

Switches and Actuator Accessories

Adv. Switch Pack SP-2

Code	Description
SP2S	Silver Contacts - Mechanical
SP2SEU	Silver De-Rate to 70VDC/48VAC Max for EU Service - Mechanical
SP2G	Gold Contacts - Mechanical
SP2GEU	Gold De-Rated to 70VDC/48VAC Max for EU Service - Mechanical
SP2Z	2-Wire Proximity
SP2N	NAMUR Proximity
SP2P	3-Wire PNP Proximity
SP2NP	3 Wire NPN Proximity
SP2B	Effector IS-2002-AROA Proximity

Adv. Switch Pack SP-3

Code	Description
SP3S48	Silver Contacts 48V - Mechanical
SP3S48CL	Silver Contacts 48V w/ Clipped Resistor - Mechanical
SP3S110	Silver Contacts 110V - Mechanical
SP3S110CL	Silver Contacts 110V w/ Clipped Resistor - Mechanical
SP3S240	Silver Contacts 230V - Mechanical
SP3S240CL	Silver Contacts 230V w/ Clipped Resistor - Mechanical
SP3G30	Gold Contacts 30V - Mechanical
SP3G30CL	Gold Contacts 30V w/ Clipped Resistor - Mechanical
SP3GSA	Gold Contacts 30V, Simple Apparatus - No LEDs - Mechanical
SP3Z	2-Wire Proximity
SP3N	NAMUR Proximity
SP3P	3-Wire PNP Proximity
SP3NP	3 Wire NPN Proximity

Value Switch Package

Code	Description
VSPG30	Gold Contacts 30V
VSPN	NAMUR Proximity
VSP3P	3-Wire PNP Proximity
VSPS48	Silver Contacts 48V
VSPZ	2-Wire Proximity

Actuator Accessories Position Indicator (Dia-Flo Only)

Code	Description
P1	Position Indicator

Limit Switches

Code	Description
LS1	Microswitch BZE6 - 2RN
LS2	Microswitch BAF1 - 2RN
LS3	Microswitch DTE6 - 2RN
LS4	Microswitch DTF2 - 2RN
LS5	Microswitch EXQ
LS6	Microswitch EXDQ
LS7	Microswitch LSA1A
LS8	Westlock 3479 Model 3
LS9	GO 74-13528-A1
LS9C	GO 73-13528-A2
LS11	Westlock E3479 MOD3
LS13	Westlock 9880
LS14	Westlock E9880
LS15	Westlock 99920-AB
LS16	Westlock 9881
LS17	Westlock E9881
LS18	Westlock 9920
LS19	Westlock E9920
LSSpec	Special

Limit Switches, Yoke Mounted

Code	Description
YOKE MOUNTED	
LS1Y	Microswitch BZE6 - 2RN
LS2Y	Microswitch BAF1 - 2RN
LS3Y	Microswitch DTE6 - 2RN
LS4Y	Microswitch DTF2 - 2RN
LS5Y	Microswitch EXQ
LS6Y	Microswitch EXDQ
LS7Y	Microswitch LSA1A
LS8Y	Westlock 3479 Model 3
LS9Y	GO 74-13528-A1
LS10Y	Namco EA700-80100
LS12Y	Namco EA170-34100/35100
LSSpecY	Special

Mechanical Accessories

Code	Description
AO	Adjustable Opening Stop
AOH	Adjustable Opening Stop w/ Handwheel
AHODUP	Special Adjustable Opening Stop w/ Handwheel for Dupont
ATS	Adjustable Travel Stop
HWC	Hand Wheel Closing Device
HWO	Hand Wheel Opening Device
JO	Jack Opening Device (#32250)
THC	Adjustable Travel Stop, Handwheel Closing Device
TO	Adjustable Travel Stop, Adjustable Opening Stop
TOHC	Adjustable Travel Stop, Adjustable Opening Device, Handwheel Closing Device
TOHO	Adjustable Travel Stop, Adjustable Opening Stop, Handwheel Opening Device
TOWO	Adjustable Travel Stop, Adjustable Opening Device, Wrench Opening Device
WO	Wrench Opening Device

Manual Bonnet Switch

Code	Description
MBSWVG	Mechanical Gold (Close only)
MBSWMS	Mechanical Silver (Close only)

Actuator Hardware Options

Code	Description
HW1	SS Airmotor Bolts
HW2	SS Accessory Brackets
HW3	SS Tubing and Fittings
HW4	Plastic Tubing /Brass Fittings
HW5	PVC Coated Tubing /Brass Fittings
HW6	PVC Coated Tubing /SS Fittings
HW9	PTFE Tubing and Stainless Steel Fittings
HW10	Breather Vent Filter Stainless Steel
HW11	Breather Vent Filter BRS
HW12	Nylon Actuator Vent Plug

Figure Numer: 1-F-428L-6-0-0-TM17-36-M7-A209-VSPS48-

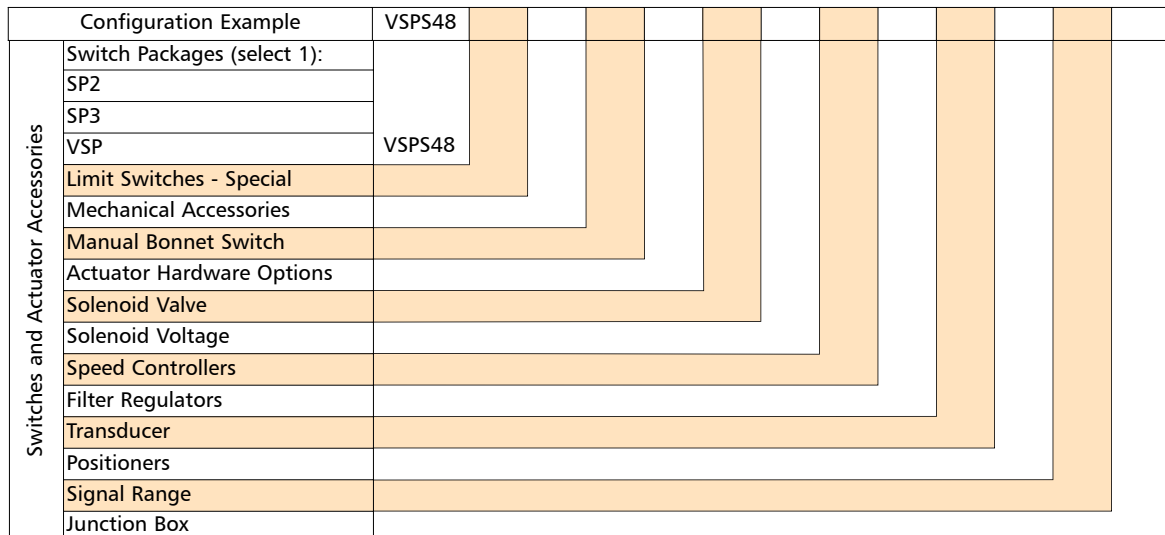

Pure-Flo Valve Figure Numbers

Switches and Actuator Accessories (cont.)

Solenoid Valve

Code	Description
SV1	Asco 8320G184
SV2	Asco EF8320G184
SV3	Asco 8345G1
SV4	Asco EF8345G1
SV8	Asco EF8320G202
SV14	Burkert Series 6014
SV15	Burkert Series 6015

Solenoid Voltage

Code	Description
V1	120V / 60HZ
V2	24VDC
V3	240V / 60HZ
VSpec	Special

Speed Controllers

Code	Description
SC	Schrader 337-1001
SC2	Whitey needle valve SS-1RMA
SCSpec	Special

Filter Regulators

Code	Description
FR1	Conoflow GFH60XTKEG3G
FR1X2	Two Conoflow GFH60XTKEG3G
FR2	Fisher 67FR
FR2X2	Two Fisher 67FR
FRSpec	Special

Transducer

Code	Description
TR1	Conoflow GT2108ED
TR1630	Conoflow GT6108ED
TRIPH	Moore IPH/4-20MA/3-15PSIG/20PSI/FR1/WDNS
TRWS	Watson Smith S3-4904-3XR
TRSpec	Special

Positioners

Code	Description
PR1	Conoflow Model 31
PR2	Conoflow Model 33
PR3	Moore 73NF
PR4	Moore 73 NB
PR5	Moore 73 NR
PR6	Conoflow P50
PR7	Conoflow P51
PR8	Conoflow P52
PRSpec	Special

Signal Ranges

Code	Description
SR1	3-15 PSI
SR2	6-30 PSI
SR3	3-9 PSI
SR4	9-15 PSI

Junction Box

Code	Description
JB	Junction Box: Standard
JBSpec	Special

Figure Numer: 1-F-428L-6-0-0-TM17-36-M7-A209-VSPS48-

Configuration Example		VSPS48												
Switches and Actuator Accessories	Switch Packages (select 1):													
	SP2													
	SP3													
	VSP	VSPS48												
	Limit Switches - Special													
	Mechanical Accessories													
	Manual Bonnet Switch													
	Actuator Hardware Options													
	Solenoid Valve													
	Solenoid Voltage													
	Speed Controllers													
	Filter Regulators													
	Transducer													
Positioners														
Signal Range														
Junction Box														

Pure-Flo Valve Figure Numbers

Service Preparation and Quality Documents

Special Service Preparation	
Code	Description
BAG	Cleaned and Bagged
DS	Dual Scale (PSI/BAR) Gauges
EU_SERVICE	European Union Service
NPC	No Polishing Compound
OXY	Oxygen
SIFREE	Silicone Free Preparation
SPEC	Customer Special
TOB	Tobacco
VAC	Vacuum

Special Quality Documents	
Code	Description
SQDB	CMTR (Body)
SQD1	CMTR (body, tube, weld, weld rod)
SQD2	C of C (seat & shell pressures)
SQD3	C of C Profilometer Tape for each body
SQDBIO	C of C Diaphragm USP XXVIII Class VI Biological Reactivity
SQD5	C of C Body/Stud/Nut CMTR and C of C to ASME Section VIII
SQD6	C of C Tube CMTR, Tank Bottom Valve
SQD7	C of C Weld Rod CMTR, Tank Bottom Valve

Figure Numer: 1-F-428L-6-0-0-TM17-36-M7-A209-VSPS48-SQDB

Configuration Example	SQDB
Special Service Preparation	
Special Quality Documents	SQDB

Code Description
BODY TYPE

RTBV Radial Tank Bottom Valve
 8D Bio-Tek® Forged 1.4435 SS
 FD Forged 1.4435 SS

BODY ENDS (BUTTWELD)

423X 18 GA BT, Max Cutback , STD Length
 423XL 18 GA BT, Max Cutback , Non-STD LG.

428X 16 GA Max Cut Standard Length
 428XL 16 GA Max Cut Nonstandard Length
 429X 14 GA Max Cut Standard Length
 433 ANSI Flanged
 489 RTBV, 90 Degree 16 GA Butt Weld
 490 RTBV, 90 Degree Tri-Clamp

SECOND END CODE (CLAMP)

X23X 18 GA BT, Max Cutback STD Length
 X23XL 18 GA BT, Max Cutback Non-STD LG
 X28X 16 GA BT, Max Cutback STD Length
 X28L By 16 Gauge Extended Tangent BW
 X28XL 16 GA BT, Max Cutback Non-STD LG
 X29L By 14 Gauge Extended Tangent BW
 XX29X 14 GA BT, Max Cutback STD Length

BONNETS, HANDWHEEL

16 Standard Bio-Tek® Bonnet
 17 Sealed Bio-Tek® Bonnet
 902 Cast Iron Indicating
 902S Cast Iron Indicating - Sealed
 912 Stainless Steel (316) Indicating
 912S Stainless Steel (316) Indicating - Sealed

932 Bronze Indicating
 932S Bronze Indicating - Sealed
 933 Bronze Indicating with Travel Stop (1/2" - 4")
 933S Bronze Indicating with Travel Stop - Sealed (1/2" - 4")
 942 Double Iron Indicating
 942S Double Iron Indicating - Sealed
 943 Double Iron Indicating with Travel Stop
 943S Double Iron Indicating with Travel Stop - Sealed
 950 Rising Handwheel with Travel Stop
 961 Plastic PAS Non-Indicating with Travel Stop

WFI HOT LOCKOUT BONNET

LBA 115VAC/60HZ
 LBD 24VDC
 LBD1 24VDC with Position feedback
 LBM 24VDC with Mech Switch Output
 LBP 24VDC with Solid State Switch Output

ACTUATED BONNETS (BRONZE)

33 Actuated
 33S Actuated - Sealed

OPTIONAL BONNET INTERNALS

M11 316 Stainless Steel Stem
 M12 PSU Cap
 M13 Stainless Steel Compressor (Bio-Tek®)
 M14 Clear Cap

DIAPHRAGMS

A Soft Natural Rubber (FDA)
 16 EPDM Compound 16 (FDA)
 B16 Biotek EPDM Compound 16
 C Hypalon
 H EPDM (FDA)
 NB NB
 TM PTEE (FDA)/Grade 16 BC
 TFM1700 TFM1700 PTFE (FDA)
 WB White Butyl (FDA)
ADV. SWITCH PACK SP-2.5
 SP5B Effector IS-2002-AROA Proximity
 SP5G Gold Contacts - Mechanical
 SP5GEU Gold De-Rated to 70VDC/48VAC Max for EU Service - Mechanical
 SP5N NAMUR Proximity
 SP5NP 3 Wire NPN Proximity
 SP5P 3-Wire PNP Proximity
 SP5S Silver Contacts - Mechanical
 SP5SEU Silver De-Rated to 70VDC/48VAC Max for EU Service - Mechanical
 SP5Z 2-Wire Proximity

SOLENOID VALVE

SV5 Burkert 300-C-1/16 -F-R-1/8-VOL (Advantage)
 SV6 Burkert 311-C-5/64 -F-BR-1/8-VOL (Advantage)

SPECIAL SERVICE PREPARATION

CS Controlled Sulfur Body (0.005-0.017%)

Fabrication Type		Purge Valve Orientation		Valve Number for Fabrication	
Code	Description	Code	Description	Code	Description
GMP	GMP	B	Back	M	Main Valve
HSA	Horizontal Sterile Access	F	Front	2	Second Valve
SA	Sterile Access	L	Left	3	Third Valve
SPEC	Special	LL	Left Special	4	Fourth Valve
		LR	Left/Right Special	5	Fifth Valve
		R	Right	6	Sixth Valve
		RL	Right/Left Special	7	Seventh Valve
		RR	Right Special	8	Eighth Valve
				9	Ninth Valve
				10	Tenth Valve

Purge Location	
Code	Description
P1	Purge located closest to main valve end 1
P2	Purge located closest to main valve end 2
PB	Purge located at both valve ends (P1 and P2)

Note: See pages 5-11 for additional figure numbers.

Sterile Access Example

Sterile Access single valve fabrication with a 1.5" forged stainless steel main valve and a 0.5" forged purge tube closest to the second end. The main valve has buttweld ends, 25 Ra polished interior, a 950 PBT manual bonnet and a modified PTFE diaphragm. The purge tube has a tri-clamp end.

Single Valve Fabrication Figure Number: SA-1.5-F-428L-.5-X19-P2-6-0-0-TM17-950-SQD1

Configuration Example		SA	1.5	F	428L	.5	X19	P2	6-0-0	TM17	950			SQD1
Single Valve Fabrication	Fabrication Type	SA												
	Valve Size		1.5											
	Body Type			F										
	Body End Code				428L									
	Second End Code													
	Purge Tube Size					.5								
	Purge Tube End Code						X19							
	Purge Location								P2					
	Polish Selections (pg 5)									6-0-0				
	Diaphragm Selection (pg 6)										TM17			
	Bonnets & Bonnet Options (pg 7)											950		
	Actuator Options (pg 8)													
	Switches & Actuator Accessories (pg 9-10)													
Service Preparation & Quality Doc. (pg 11)														SQD1

Sterile Access Orientations

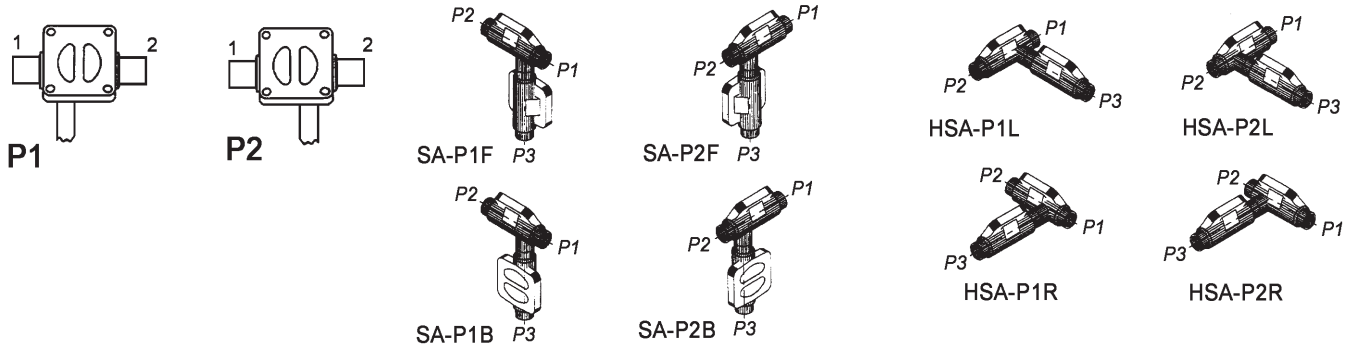

Pure-Flo Valve Figure Numbers

Sterile Access & GMP Fabrications (cont.)

GMP Example

GMP two valve fabrication with a 2" forged stainless steel main valve and a 0.5" forged purge valve closest to the second end and facing to the right. The main valve has Tri-Clamp ends, 25 Ra polished interior, a reverse acting advantage actuator with a 60lb spring, an SP-2 switch pack with silver mechanical contacts and a modified PTFE diaphragm. The secondary valve has 16 gauge ends, 25-inch polished interior, a PAS hand-wheel operated bonnet with sanitary internals and a modified PTFE diaphragm.

Fabrication Figure Number: GMP-2-2-.5

Configuration Example		GMP	2	2	.5
Fabrication	Fabrication Type	GMP			
	Two Valve Fabrication		2		
	Main Valve Size			2	
	Second Valve Size				.5

Main Valve Figure Number: GMP-M-2-F-419-P2-R-6-0-0-TM17-36-M7-A216-SP2S-SQD1

Configuration Example		GMP	M	2	F	419		P2	R		6-0-0	TM17	36-M7	A216	SP2S	SQD1
Main Valve	Fabrication Type	GMP														
	Valve Number		M													
	Valve Size			2												
	Body Type				F											
	Body End Code					419										
	Second End Code															
	Purge Location							P2								
	Purge Valve Orientation								R							
	Tube Extension															
	Polish Selections (pg 5)										6-0-0					
	Diaphragm Selection (pg 6)											TM17				
	Bonnets & Bonnet Options (pg 7)												36-M7			
	Actuator Options (pg 8)													A216		
Switches & Actuator Accessories (pg 9-10)														SP2S		
Service Preparation & Quality Doc. (pg 11)																SQD1

Second Valve Figure Number: GMP-2-.5-F-428L-R-6-0-0-TM17-963-M2-SQD1

Configuration Example		GMP	2	.5	F	428L	R		6-0-0	TM17	963-M2					SQD1
Second Valve	Fabrication Type	GMP														
	Valve Number		2													
	Valve Size			.5												
	Body Type				F											
	Body End Code					428L										
	Purge Valve Orientation						R									
	Tube Extension															
	Polish Selections (pg 5)								6-0-0							
	Diaphragm Selection (pg 6)									TM17						
	Bonnets & Bonnet Options (pg 7)										963-M2					
	Actuator Options (pg 8)															
	Switches & Actuator Accessories (pg 9-10)															
	Service Preparation & Quality Doc. (pg 11)															

GMP Orientations

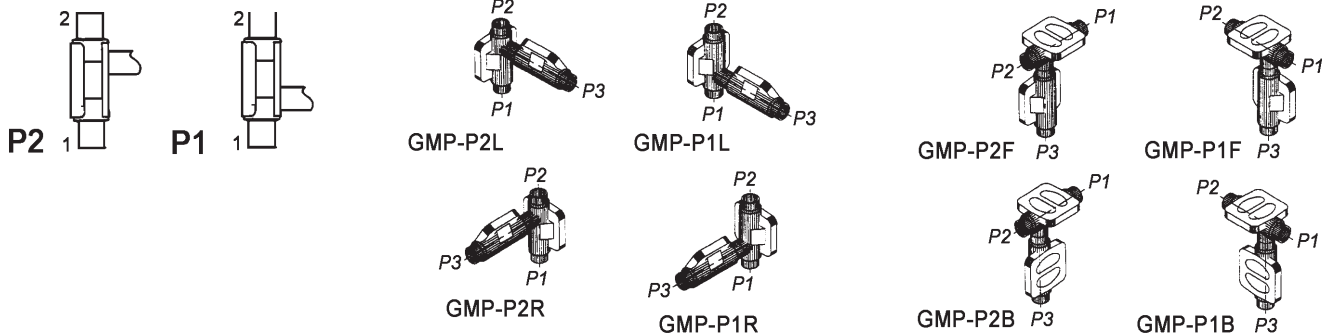

Fabrication Type

Code	Description
ZSB BT	Zero static Block Body Tee
ZSBBHV	Zero static Block Body U-Bend: Horizontal Tube - Vertical Valve
ZSBBVV	Zero static Block Body U-Bend: Vertical Tube - Vertical Valve
ZSBBS	Zero static Back to Back Sample Valve
ZSHH	Zero static Horizontal Tube - Horizontal Valve
ZSVH	Zero static Vertical Tube - Horizontal Valve

Body Type

Code	Description
SVBT	Sample Valve Bio-Tek® (R)
SVPF	Sample Valve Pure-Flo

Sample Valve Outlet Side

Code	Description
R	Ported on Right Side of Valve (Standard)
L	Ported on Left Side of Valve

U Bend Tube Orientation (Optional)

Option	Option Description
HV	Horizontal U-Bend Tube with Vertical Valve Orientation
VV	Vertical U-Bend Tube with Vertical Valve Orientation
USPEC	Special U-Bend Orientation

Body Ends

Code	Description
419R	.75" Tri-Clamp

Note: See pages 5-11 for additional figure numbers.

Zero Static Back-to-Back Sample Example

Zerostatic Block Body with a .75" wrought stainless steel main valve and a 1.5" tube. All three outlets are butt-welded. Interior finish: RA 25, PBT hand-wheel operated bonnet and a modified PTFE diaphragm. Bio-Tek sample valve with .75" Tri-clamp connection.

Main Valve Figure Number: ZSBBS-.75-428-1.5-428-.5-SVBT-419R-R-W-6-1-0-SQD1

Configuration Example		ZSBBS	.75	428	1.5	428	.5	SVBT	419R	R	W	6-1-0	SQD1
Main Valve	Fabrication Type	ZSBBS											
	Valve Size		.75										
	Body End Code			428									
	Zerostatic Tube Size				1.5								
	U-Bend Tube Orientation*					428							
	Zerostatic Tube End Code						428						
	Secondary Valve Size						.5						
	Secondary Valve Type							SVBT					
	Secondary Valve End Type								419R				
	Secondary Outlet Orientation									R			
	Sample Outlet Side												
	Body Material										W		
	Polish Selections (pg 5)											6-1-0	
	Diaphragm Selection (pg 6)												
Service Preparation & Quality Doc. (pg 11)												SQD1	

* For a U-Bend Vertical Tube, enter VV. For Horizontal Tube, enter HV. All other figure numbers remain the same.

Main Multiport Valve Topworks Figure Number: .75-N-TM17-950

Configuration Example		.75	N	TM17	950
Topworks	Valve Size	.75			
	Body (Not Supplied)		N		
	Diaphragm (pg 6)			TM17	
	Bonnet (pg 7)				950
	Options (pg 8-10)				

Zero Static Back-to-Back Sample Valve

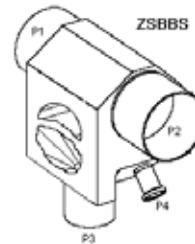

Zero Static Back-to-Back Sample Valve with U-Bend

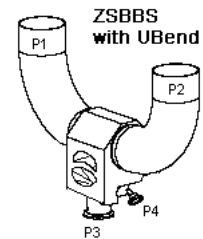

Sample Multiport Valve Topworks Figure Number: .5-N-TM17-18

Configuration Example		.5	N	TM17	18
Topworks	Valve Size	.5			
	Body (Not Supplied)		N		
	Diaphragm (pg 6)			TM17	
	Bonnet (pg 7)				18
	Options (pg 8-10)				

Zero Static Block Body Tee Example

ZSBBT with a 0.5" wrought stainless steel main valve and a 2" tube. All three outlets have tri-clamp ends. RA 25 ID, both interior and exterior electropolish, PAS hand-wheel operated bonnet, sanitary internals and EPDM diaphragm.

Valve Figure Number: ZSBBT-.5-W-419-2-X19-6-1-3-17-963-M2-SQD1

Configuration Example		ZSBBT	.5	W	419	2	X19	6-1-3	17	963-M2	SQD1
Main Valve	Fabrication Type	ZSBBT									
	Valve Size		.5								
	Body Type			W							
	Body End Code				419						
	Zerostatic Tube Size					2					
	Zerostatic Tube End Code						X19				
	Zerostatic Tube Second End Code										
	Polish Selections (pg 5)							6-1-3			
	Diaphragm Selection (pg 6)								17		
	Bonnets & Bonnet Options (pg 7-10)									963-M2	
Service Preparation & Quality Doc. (pg 11)										SQD1	

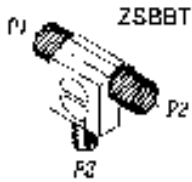

Zero Static Block Body U-Bend Example

Zerostatic Block Body Tee U-bend (Vertical Tube, Vertical Valve) with a 1" wrought stainless steel main valve and a 1.5" tube. The outlet of the valve body has Tri-Clamp ends. The tube has 1.5" butt-weld 16 gauge ends. Interior finish: RA 25, PAS hand-wheel operated bonnet-sealed, sanitary internals and a PTFE diaphragm.

Valve Figure Number: ZSBBVV-1-W-419-1.5-X28-6-1-0-TM17-963S-M2-SQD1

Configuration Example		ZSBBVV	1	W	419	1.5	X28	6-1-0	TM17	963S-M2	SQD1
Main Valve	Fabrication Type	ZSBBVV									
	Valve Size		1								
	Body Type			W							
	Body End Code				419						
	Zerostatic Tube Size					1.5					
	Zerostatic Tube End Code						X28				
	Zerostatic Tube Second End Code										
	Polish Selections (pg 5)							6-1-0			
	Diaphragm Selection (pg 6)								TM17		
	Bonnets & Bonnet Options (pg 7-10)									963S-M2	
Service Preparation & Quality Doc. (pg 11)										SQD1	

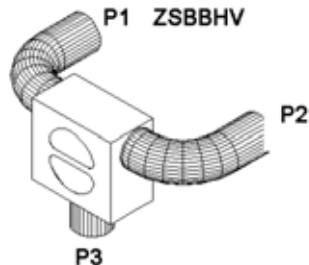
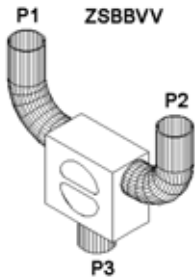

Pure-Flo Valve Figure Numbers Zero Static Fabrications (cont.)

Zero Static - Forged Bodies Example

Zerostatic with 1" forged triclamp main valve and 1.5" buttweld tube. Interior finish is 20 Ra with Electropolish ID and OD. PTFE diaphragm with EPDM backing cushion. PAS handwheel operated bonnet. Purge valve oriented on right side.

Valve Figure Number: ZSHH-1-F-419-1.5-X28-R-8-0-3-TM17-963-M2-SQD1

Configuration Example		ZSHH	1	F	419	1.5	X28		R	8-0-3	TM17	963-M2	SQD1
Main Valve	Fabrication Type	ZSHH											
	Valve Size		1										
	Body Type			F									
	Body End Code				419								
	Zerostatic Tube Size					1.5							
	Zerostatic Tube End Code						X28						
	Zerostatic Tube Second End Code												
	Purge Valve Orientation								R				
	Polish Selections (pg 5)									8-0-3			
	Diaphragm Selection (pg 6)										TM17		
Bonnets & Bonnet Options (pg 7-10)											963-M2		
Service Preparation & Quality Doc. (pg 11)												SQD1	

Zero-Static Orientations

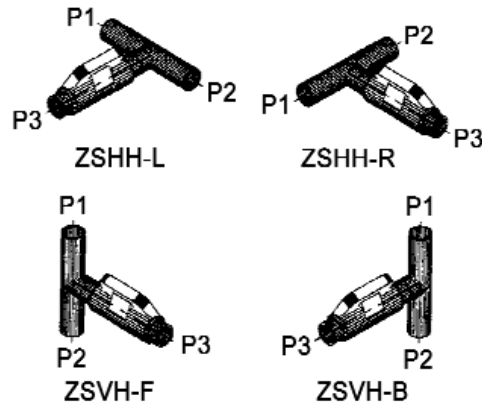

Type of Valve

Option	Description
DV2W	Divert Valve 2-way
DV3W	Divert Valve 3-way
DV4W	Divert Valve 4-way
DV5W	Divert Valve 5-way
DV6W	Divert Valve 6-way
CHRO	Chromatography
CHRONBP	Chromatography Valve without Bypass
CRO	Cross over Valve
CROD	Cross over Valve with Drain Angle
SB1	Sterile Barrier Valve Option 1
SB2	Sterile Barrier Valve Option 2
DIDO	Double Inlet Double Outlet Diverter Valve
BP	Pure-Flo Valve with Bypass Option
ISG	Integral Sterile Access GMP Valve
VSPEC	Special Valve Type

Type

Option	Description
BT	Bio-Tek®
PF	Pure-Flo

Outlet Option

Option	Description
Refer to the drawing that corresponds to the type chosen	
1	Outlet Configuration 1
2	Outlet Configuration 2
3	Outlet Configuration 3
4	Outlet Configuration 4
5	Outlet Configuration 5
6	Outlet Configuration 6
7	Outlet Configuration 7
8	Outlet Configuration 8
OSPEC	Special Outlet Configuration

Material

Option	Description
W	Wrought 316L
WA	Wrought AL6XN
WC2	Wrought C-22
WC6	Wrought C-276
WT	Wrought Titanium
BSPEC	Special Material

Flow Through (Optional)

Option	Description
DVFT	Divert Flow-Through

Note: See pages 5-11 for additional figure numbers.

Divert Example

2-Way Divert Valve with a 1.5" wrought stainless steel body. The inlet and outlets have Tri-Clamp ends. The outlet is Option 2. The Interior finish: RA 25. Fail close Advantage® Actuator 60# spring. Modified PTFE diaphragm.

Valve Figure Number: DV2W-1.5-2-419-W-6-1-0-SQD1

Configuration Example		DV2W	1.5		2	419	W	6-1-0	SQD1
Main Valve	Fabrication Type	DV2W							
	Valve Size		1.5						
	Body Type (.5" only)								
	Divert Outlet Option				2				
	Divert End Connections					419			
	Body Material						W		
	Polish Selections (pg 5)							6-1-0	
	Service Preparation & Quality Doc. (pg 11)								SQD1

Topworks

Topworks for Multiport and Specialty Valves are configured separately from the bodies; they do not appear in the valve figure number but are listed after the body configuration. Once the Multiport Valve has been described, the Topworks configuration will appear.

Main Valve Topworks Figure Number: 1.5-N-TM17-31-M7-A216

Configuration Example		1.5	N	TM17	31-M7	A216
Topworks	Valve Size	1.5				
	Body (Not Supplied)		N			
	Diaphragm (pg 6)			TM17		
	Bonnet (pg 7)				950	
	Options (pg 8-10)					A216

Secondary Valve Topworks Figure Number: 1.5-N-TM17-31-M7-A216

Configuration Example		1.5	N	TM17	31-M7	A216
Topworks	Valve Size	1.5				
	Body (Not Supplied)		N			
	Diaphragm (pg 6)			TM17		
	Bonnet (pg 7)				950	
	Options (pg 8-10)					A216

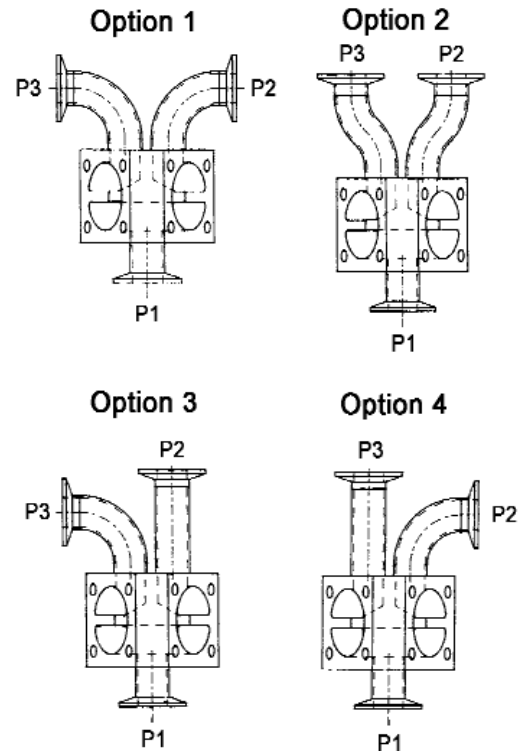

Pure-Flo Valve Figure Numbers

Multiport Valves (cont.)

Integral Sterile Access GMP Example

ISG Valve with a 2" wrought stainless steel body. Secondary valve is 1.5", ported on right side of valve. The outlet is Option 5. The Interior finish: RA 20. Fail close Advantage® Actuator 60# spring. Modified PTFE diaphragm.

Main Valve Figure Number: ISG-2-5-1.5-R-W-8-1-0-SQD1

Configuration Example		ISG	2	5	1.5		R	W	8-1-0	SQD1
Main Valve	Fabrication Type	ISG	2							
	Valve Size		2							
	Body Type (.5" only)									
	Outlet Option			5						
	Second Valve Size				1.5					
	Valve Type (.5" only)									
	Sample Outlet Side						R			
	Body Material							W		
	Polish Selections (pg 5)								8-1-0	
	Service Preparation & Quality Doc. (pg 11)									SQD1

Topworks

Topworks for Multiport and Specialty Valves are configured separately from the bodies; they do not appear in the valve figure number but are listed after the body configuration. Once the Multiport Valve has been described, the Topworks configuration will appear.

Main Valve Topworks Figure Number: 2-N-TM17-31-M7-A216

Configuration Example		2	N	TM17	31-M7	A216
Topworks	Valve Size	2				
	Body (Not Supplied)		N			
	Diaphragm (pg 6)			TM17		
	Bonnet (pg 7)				31-M7	
	Options (pg 8-10)					A216

Secondary Valve Topworks Figure Number: 1.5-N-TM17-31-M7-A216

Configuration Example		1.5	N	TM17	31-M7	A216
Topworks	Valve Size	1.5				
	Body (Not Supplied)		N			
	Diaphragm (pg 6)			TM17		
	Bonnet (pg 7)				31-M7	
	Options (pg 8-10)					A216

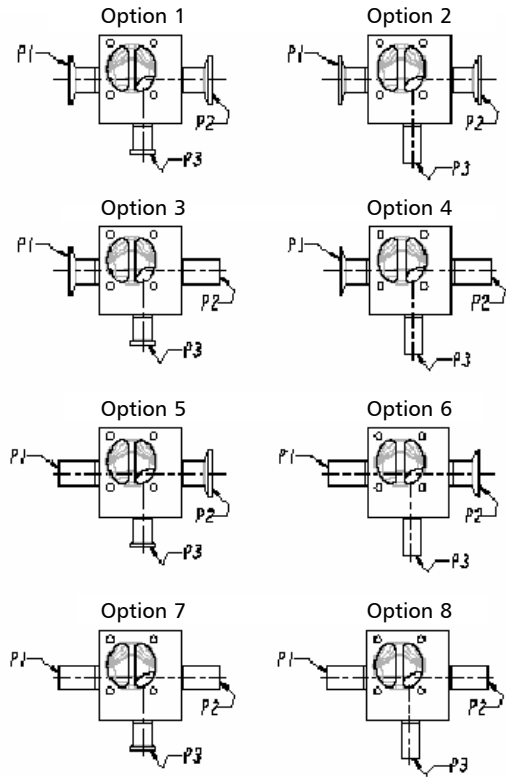

End Connection Options

CONDITIONS and TERMS of SALE of ITT INDUSTRIAL & BIOPHARM GROUP (IBG)
(hereinafter referred to as Company)

WARRANTY - Company warrants title to the product(s) and, except as noted with respect to items not of Company's manufacturer, also warrants the product(s) on date of shipment to Purchaser, to be of the kind and quality described herein, and free of defects in workmanship and material. **This warranty is expressly in lieu of all other warranties, including but not limited to implied warranties of merchantability and fitness, and constitutes the only warranty of the company with respect to the product(s).**

If within one year from date of initial operation, but not more than eighteen months from date of shipment by Company of any item of product(s), Purchaser discovers that such item was not as warranted above and promptly notifies Company in writing thereof. Company shall remedy such nonconformance by, at Company's option, adjustment or repair or replacement of the item and any affected part of the product(s). Purchaser shall assume all responsibility and expense for removal, reinstallation, and freight in connection with the foregoing remedies. The same obligations and conditions shall extend to replacement parts furnished by Company hereunder. Company shall have the right of disposal of parts replaced by it. Purchaser agrees to notify Company, in writing, of any apparent defects in design, material or workmanship, prior to performing any corrective action back chargeable to the Company. Purchaser shall provide a detailed estimate of the material, labor costs associated with proposed remedy for expeditious review and approval by the Company.

Seller neither assumes, nor authorizes any person to assume for it, any other obligation in connection with the sale of its engineering designs or products. This warranty shall not apply to any products or parts of products which (a) have been repaired or altered outside of Seller's factories or authorized service centers, in any manner; or (b) have been subjected to misuse, negligence or accidents; or (c) have been used in a manner contrary to Seller's instructions or recommendations. Seller shall not be responsible for design errors due to inaccurate or incomplete information supplied by Buyer or its representatives.

Any separately listed item of the product(s) which is not manufactured by the company is not warranted by the company and shall be covered only by the express warranty, if any, of the manufacturer thereof.

This states purchaser's exclusive remedy against company and its suppliers relating to the product(s), whether in contract or in tort or under any other legal theory, and whether arising out of warranties, representations, instructions, installations or defects from any cause. Company and its suppliers shall have no obligation as to any product which has been improperly stored or handled, or which has not been operated or maintained according to instructions in Company or supplier furnished manuals.

LIMITATION OF LIABILITY - Neither Company nor its suppliers shall be liable, whether in contract or in tort or under any other legal theory, for loss of use, revenue or profit, or for cost of capital or of substitute use or performance, or for incidental, indirect, or special or consequential damages, or for any other loss or cost of similar type, or for claims by Purchaser for damages of Purchaser's customers. Likewise, Company shall not, under any circumstances, be liable for the fault, negligence, or wrongful acts of Purchaser or Purchaser's employees, or Purchaser's other contractors or suppliers.

In no event shall company be liable in excess of the sales price of the part(s) or product found defective.

GENERAL - (a) Company will comply with all laws applicable to Company. Compliance with OSHA or similar federal, state or local laws during any operation or use of the product(s) is the sole responsibility of Purchaser. (b) The laws of the State of New York shall govern the validity, interpretation and enforcement of any contract of which these provisions are a part, without giving effect to any rules governing the conflict of laws. (c) This document and any other documents specifically referred to as being a part hereof, constitute the entire contract on the subject matter, and it shall not be modified except in writing signed by both parties. Unless otherwise specified, any reference to Purchaser's order is for identification only. Assignment may be made only with written consent of both parties.

ACCEPTANCE - The determination of compliance with performance guarantees will be based on results of factory tests under controlled conditions with calibrated instruments and tested per standards of the Hydraulic Institute, ISO standards, API standards, or other nationally recognized accreditation standards mutually acceptable to Company and Purchaser.

SHIPMENT - The term "shipment" means delivery to the initial carrier in accordance with the delivery terms of this order. Company may make partial shipments. Company shall select method of transportation and route, unless terms are f.o.b. point of shipment and Purchaser specifies the method and route and is to pay the freight costs in addition to the price. When terms are f.o.b. destination or freight allowed to destination, "destination" means common carrier delivery point (within the continental United States, excluding Alaska) nearest the destination. For movement outside the United States, company shall arrange for inland carriage to port of exit and shall cooperate with Purchaser's agents in making necessary arrangements for overseas carriage and preparing necessary documents.

SPECIAL SHIPPING DEVICES - On shipments to a destination in the continental United States or Canada, Company has the right to add to the invoice, as a separate item, the value of any special shipping device (barrel, reel, tarpaulin, cradle, crib and the like) used to contain or protect the product(s) invoiced, while in transit. Full credit will be given on the return to Company of the device in a reusable condition, f.o.b. destination, freight prepaid.

DELAYS - If Company suffers delay in performance due to any cause beyond its control, including but not limited to act of God, war, act or failure to act of government, act or omission of Purchaser, fire, flood, strike or labor troubles, sabotage, or delay in obtaining from others suitable services, materials, components, equipment or transportation, the time of performance shall be extended a period of time equal to the period of the delay and its consequences. Company will give to Purchaser notice in writing within a reasonable time after Company becomes aware of any such delay.

NONCANCELLATION - Purchaser may not cancel or terminate for convenience, or direct suspension of manufacture, except on mutually acceptable terms.

STORAGE - Any item of the product(s) on which manufacture or shipment is delayed by causes within Purchaser's control, or by causes which affect Purchaser's ability to receive the product(s), may be placed in storage by Company for Purchaser's account and risk.

Terms and Conditions of Sale

TITLE AND INSURANCE - Title to the product(s) and risk of loss or damage shall pass to Purchaser at the f.o.b. point, except that a security interest in the product(s) and proceeds and any replacement shall remain in Company, regardless of mode of attachment to realty or other property, until the full price has been paid in cash. Purchaser agrees to do all acts necessary to perfect and maintain said security interest, and to protect Company's interest by adequately insuring the product(s) against loss or damage from any external cause with Company named as insured or co-insured.

INSPECTIONS / EXPEDITING - The Company wishes to clarify that it will have to restrict access to agreed upon reasonable times and only for the purpose of conducting those inspections agreed upon. We request 72 hours notice prior to each visit. We request notification prior to visits to our subcontractors and require that we accompany inspectors/expeditors on their visit(s).

TERMS OF PAYMENT - Unless otherwise stated all payments shall be Letter of Credit or Net Thirty (30) Days and in United States dollars, and a pro rata payment shall become due as each shipment is made. If shipment is delayed by Purchaser, date of readiness for shipment shall be deemed to be date of shipment for payment purposes. If at any time in Company's judgment Purchaser may be or may become unable or unwilling to meet the terms specified, Company may require satisfactory assurances or full or partial payment as a condition to commencing or continuing manufacture or making shipment; and may, if shipment has been made, recover the product(s) from the carrier, pending receipt of such assurances.

TAXES - Any applicable duties or sales, use, excise, value added or similar taxes will be added to the price and invoiced separately (unless acceptable exemption certificate is furnished).

PRODUCT RETURN - Products can be returned for credit only after receiving Company's authorization and shipping instructions. Consignor's name and address must be plainly written on the shipping tag.

PATENTS - Company shall pay costs and damages finally awarded in any suit against Purchaser or its vendees to the extent based upon a finding that the design or construction of the product(s) as furnished infringes a United States patent (except infringement occurring as a result of incorporating a design or modification at Purchaser's request) provided that Purchaser promptly notifies Company of any charge of such infringement, and Company is given the right at its expense to settle such charge and to defend or control the defense of any suit based upon such charge. **This paragraph sets forth company's exclusive liability with respect to patents.**

BUYER DATA - Timely performance is contingent upon the Purchaser supplying to the Company, when needed, all required technical information, including drawing approval, and all required commercial documentation.

NUCLEAR - Purchaser represents and warrants that the product(s) covered by this contract shall not be used in or in connection with a nuclear facility or application.

PRICES - The prices stated herein will remain firm for the period up to the stated date of shipment providing the shipment is not delayed by the customer. If shipment is delayed by the customer beyond the shipment date quoted herein, the prices will be based on the prices in effect at time of shipment, including storage and material handling costs. In no event shall the adjusted price be less than the original order price, including change orders. Prices are F.O.B. Shipping Point, unless otherwise specified. When price includes transportation and other charges pertaining to the shipment of goods, any increase in transportation rates and

other charges will be for the account of the purchaser. There will be an extra charge for any test other than that which may be normally run by the Company, or for any test performed to suit the convenience of the purchaser.

CONTROLLING PROVISIONS - These terms and conditions shall control with respect to any purchase order or sale of the Company's products. No waiver, alteration or modification of these terms and conditions whether on Purchaser's purchase order or otherwise shall be valid unless the waiver, alteration or modification is specifically accepted in writing and signed by an authorized representative of the Company.

EXPORT - If this transaction involves export, the following additional terms and conditions shall apply:

- Compliance is required for all applicable US export laws, and the export laws of the country from where the product is exported.
- **PACKING** - when packing is in IBG scope of supply, equipment will be packed, boxed or crated in accordance with the Company's standard commercial practice, for under deck export shipment, unless otherwise agreed.
- **LETTER OF CREDIT** - Unless otherwise specified in writing, payment shall be made by irrevocable letter of credit in form acceptable to Company, confirmed by a major USA bank, acceptable to the company and providing for payment in full in United States dollars against presentation of United States inland shipping documents and invoices, such letter of credit to be established prior to company's acceptance of the order. The letter of credit shall also provide that in the event Company is, for any reason beyond its control, prevented from making shipment from Company's factory or delivery at the port of embarkation, a certificate of manufacture of the whole or any part of the goods shall constitute delivery of such whole or any part of the goods and payment in full of any and all drafts drawn against the letter of credit for the goods so "delivered" shall be made upon presentation of such certificates of manufacture in lieu of United States inland shipping documents. In the event that Company is prevented by law, or otherwise, from making shipment from Company's factory or delivery at port of embarkation of the goods or any part thereof, on completion of manufacture, Company reserved the right to place the goods in storage for the Purchaser's account and risk. Any charges incurred in this connection will be for the account of the Purchaser at cost and will be payable upon demand. In regions where Letters of Credit are not available, surety bonds will be utilized in lieu of the bank guarantee.
- **COMPANY AS AGENT** - If Company makes or arranges for ocean shipment, Company shall act as agent for the Purchaser and reserves the right to procure full insurance coverage, including war risk insurance, at the expense of the Purchaser. All expenses incurred in this connection will be payable upon demand to the Company. If Company as agent applies for or secures manufacturing, financing, exporting or other licenses required by the United States Government, or any department thereof, Company shall make such applications or secure such licenses solely as agent for the purchaser, and assumes no responsibility therefore.

For more information, please contact:

Pure-Flo Headquarters

33 Centerville Road
Lancaster, PA 17603-2064 USA
Phone +1 (800) 787-3561
Phone +1 (717) 509-2200
Fax +1 (800) 239-9402

Website: www.ittpureflo.com
E-mail: pureflo.custserv@itt.com

Valve Office Locations:

Pure-Flo
110-B West Cochran
Simi Valley, CA 93065 USA
Phone +1 (800) 926-8884
Phone +1 (805) 520-7200
Fax +1 (805) 520-7205

Pure-Flo
Richards Street
Kirkham, Lancashire
PR4 2HU, England
Phone +44-1772-682696
Fax +44-1772-686006

