



ITT

Pure-Flo®

Diaphragms



Engineered for life

www.ittpureflo.com

Table of Contents

Introduction	3
Diaphragm Selection	4
Diaphragm Design	5
Grade TM17 PTFE	6-7
Grade 17 EPDM	8
Qualification Testing	9
Pressure Equipment Directive	10
Service Recommendations	11
Traceability	12
Validation	13
Packaging	14
Application	15

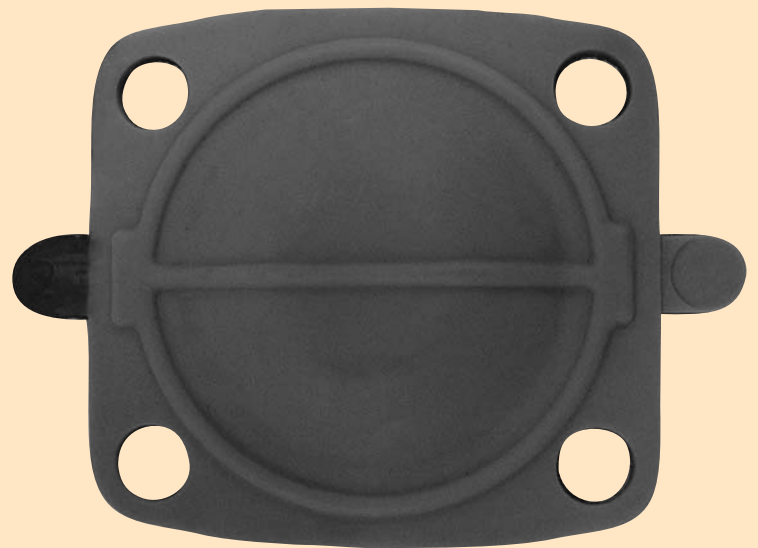
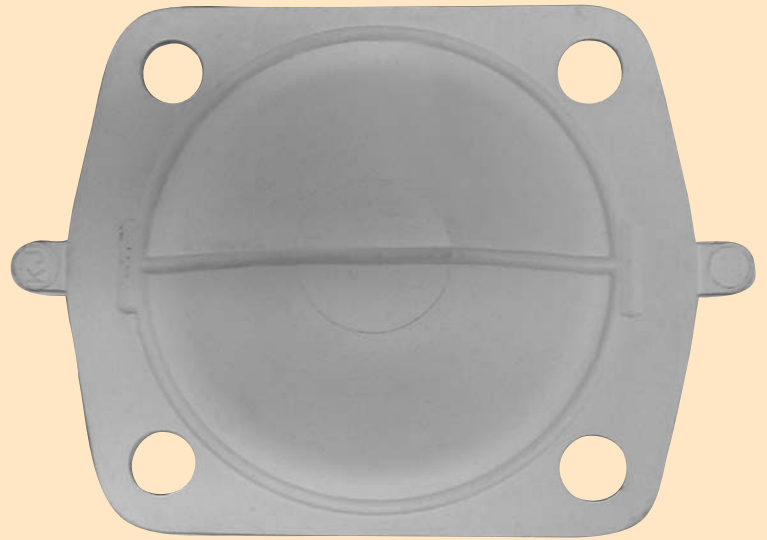

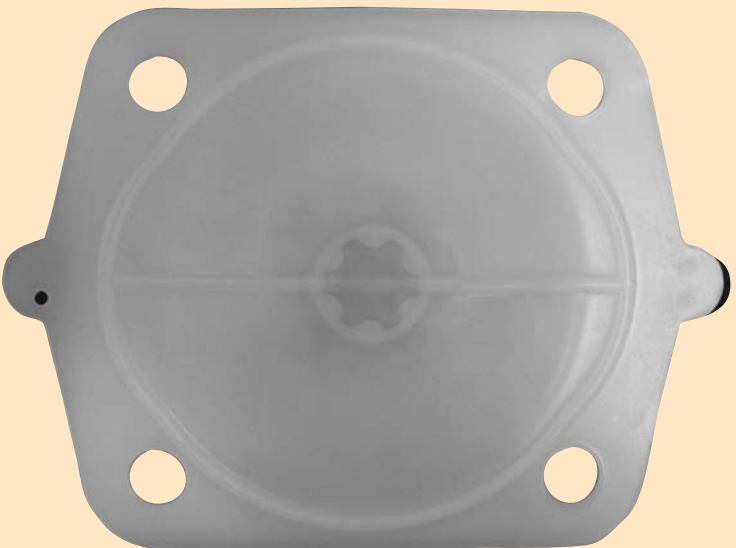
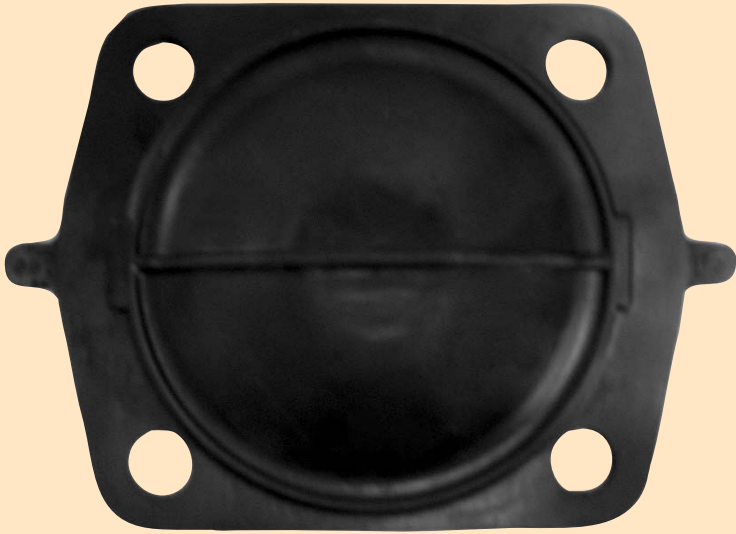

Introduction

ITT has manufactured diaphragm valves for nearly 50 years and takes great pride in its reputation for supplying the highest quality hygienic diaphragm valves to the Biopharm industry.

The diaphragm is the most critical component of a diaphragm valve. Diaphragms are the valve component that provide positive shut-off between process fluids, protects the process from the environment and in some cases protects the environment from the process.

Genuine ITT diaphragms feature:

- Engineered safety
- Reliability
- Industry proven performance
- Reduced total cost of ownership
- Complete product range
- Pure-Flo Topworks compatibility
- Material traceability
- Original Equipment Manufacturer (OEM) materials and specifications
- Global availability
- Global technical support
- Preventative maintenance program development assistance

Regulatory Compliance to:

- FDA 21CFR Part 177
- US Pharmacopeia 28 Class VI
- Pressure Equipment Directive 97/23/EC
- EMEA/410/01 - TSE/BSE (Transmitting Animal Spongiform Encephalopathy)

ITT Pure-Flo diaphragms are qualified and approved for use with Pure-Flo diaphragm valves. Other makes of diaphragms are not recommended and/or guaranteed by Pure-Flo for use with Pure-Flo valves.

Diaphragm Selection

The Pharmaceutical and Biotech industries consider a number of factors to determine the best diaphragm solution for a given process or application.

Key factors include:

- Regulatory Compliance
 - FDA
 - USP 28
 - 3A
- Biocompatibility
- Material extractibles
- Application temperatures
- Cleaning in place
- Steaming in place
- Passivation
- Failure mode

Applications within the Biotech industry are particularly sensitive to diaphragm materials because of the fact that many of the processes within the industry utilize living organisms. A balance or compromise must be struck between all of the key factors listed. Regulatory compliance in most cases is not sufficient by itself to guarantee a properly functioning system.

The worldwide network of ITT Pure-Flo technical resources are available to assist in determining the proper diaphragm for your application.



Pure-Flo® FDA Compliant Diaphragms shown clockwise: Buna N Grade P, White Butyl Grade W1, Black Butyl Grade B, Pure Gum Rubber Grade A, Grade 17, Grade TM17 PTFE

Diaphragm Type		Size		Temperature	
Grade	Material	Inch	DN	°F	°C
B	Black Butyl Rubber	1/4–12	6–300	-20–250	-29–121
17	EPDM ¹	1/4–4	6–100	-4–194 ²	-20–90 ²
P	Buna N	1/2–12	15–300	10–180	-12–82
TM17	PTFE	1/4–6	6–150	-4–329	-20–165
W1	White Butyl Rubber	1/2–8	15–200	0–225	-18–107

¹ For high temperature and/or high cycle applications, contact ITT.

² Temperature range is as follows:

-4–194°F (-20–90°C) for liquid applications

-22–285°F (-30–140°C) for continuous steam

-22–302°F (-30–150°C) for intermittent steam

Diaphragm Type		Compliance			
Grade	Material	FDA	USDA	3A	USP
B	Black Butyl Rubber	✓	✓		
17	EPDM	✓			✓
P	Buna N	✓	✓	✓**	
TM17	PTFE	✓		✓*	✓
W1	White Butyl Rubber	✓	✓		

* Class I applications

** Class III applications

Diaphragm Design

Pure-Flo's two-piece PTFE diaphragms have proven through years of outstanding service to be a robust and forgiving design. The two-piece construction eliminates the delamination problems inherent in competitive "PTFE faced" diaphragms.

PTFE diaphragms utilize a floating tube nut connection. The floating tube nut design assures that downward closing forces will be absorbed by the elastomer backing cushion and evenly distributed across the closing surface (weir) in the valve body.

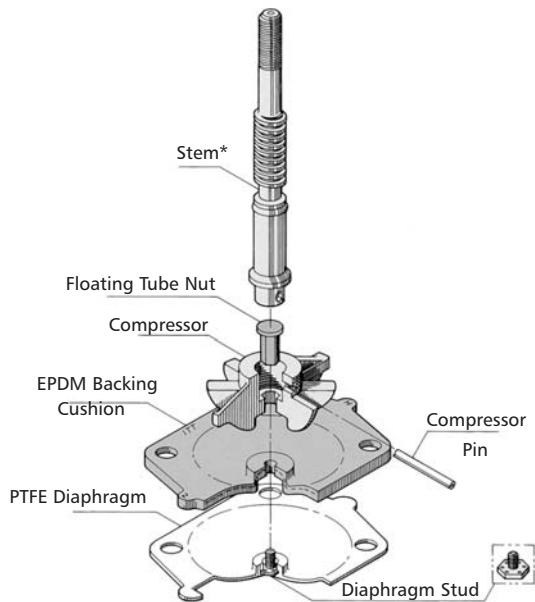

PTFE Diaphragm Compressor Assembly Showing Floating Tube Nut Design

* 970 Manual Bonnets use a T-slot compressor

Design Benefits:

- Reduced cold flow
- Improved sealability
- Longer diaphragm life
- Reduced point loading
- Eliminates stud pullout

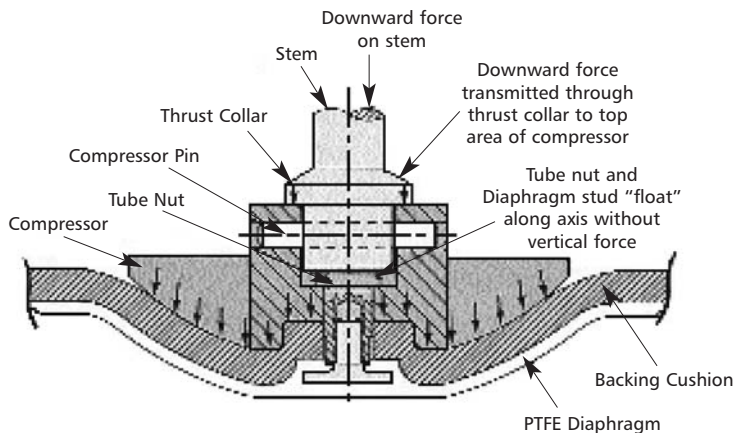

Downward force on top of compressor by-passed by tube nut and transformed to distributed pressure on bottom area of compressor. Compressor presses diaphragm over weir area of valve body.

Elastomer Diaphragm Construction

Pure-Flo elastomer diaphragms are produced by a compression molding process. The completed elastomer diaphragm is of a one-piece design. The diaphragm is constructed with layers of polymer material and a high performance woven fabric reinforcement for maximum strength and durability.

Elastomer diaphragms utilize a threaded connection to the valve compressor. PTFE and Elastomer diaphragm threads are not interchangeable.

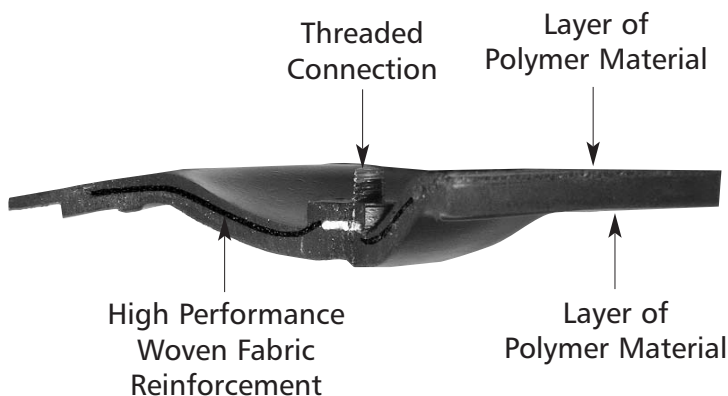

Grade TM17 PTFE

ITT Pure-Flo has developed a modified PTFE diaphragm to better withstand the critical process protocols associated with the Pharmaceutical and Bioprocessing industries, resulting in increased performance and longer life.

Type: TM17

Size Range: BT-6" (DN6 - DN150)

Temperature Rating:

-4°F to 329°F (-20°C to 165°C)

Pressure Rating:

See Pressure & Temperature chart on page 11

Material (2 Piece Construction):

Product Contact Surface: Modified PTFE with PPVE*

Backing Cushion: Grade 17 EPDM

Regulatory Compliance:

21CFR 177.1550 (a)

USP28 Class VI, Chapter <87>, <88>

21CFR177.2600 (Backing cushion)

*TM17 Material is considered a homopolymer according to ISO 12086, ASTM D-4894 due to < 1% perfluoropropyl vinyl ether (PPVE) modification

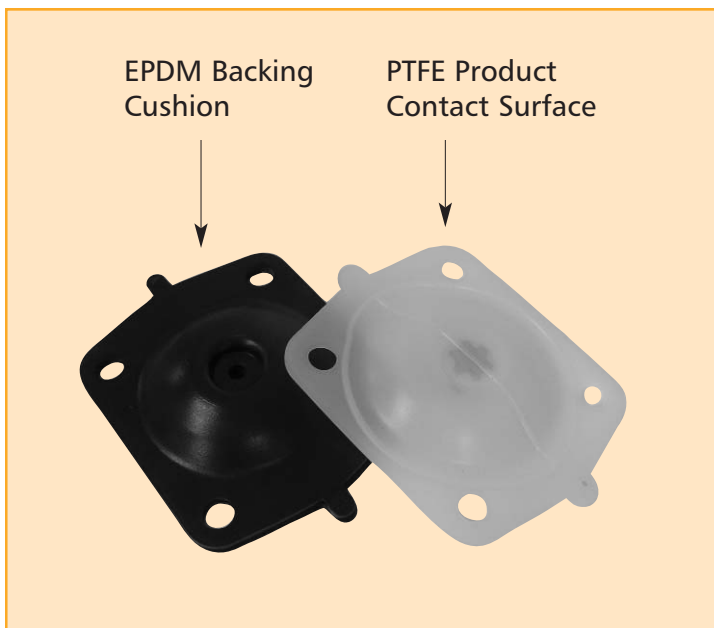

Grade TM17 PTFE

The enhanced material of the TM17 diaphragm retains all of industry proven advantages of conventional PTFE with several significant enhancements.

Overall improved sealing and flex life due to:

- Reduced cold flow
- Reduced permanent deformation under cyclic load
- Greater dimensional stability
- Reduced embrittlement
- Greater crack resistance

Improved steam life due to:

- Reduced voids
- Reduced permeation
- Reduced permanent deformation under cyclic load
- Reduced embrittlement
- Greater crack resistance

Improved cleanability due to:

- Reduced permeation
- Reduced voids, pore free surface
- Non-stick properties

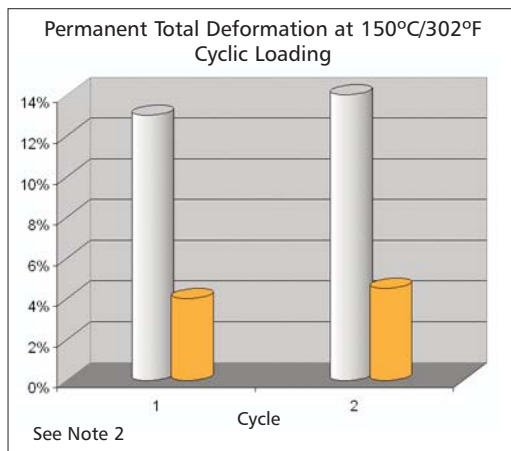
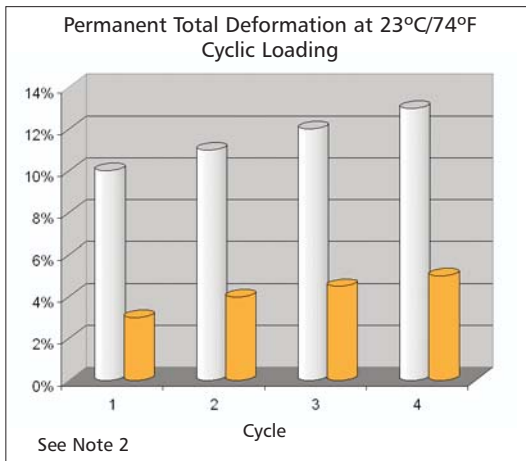
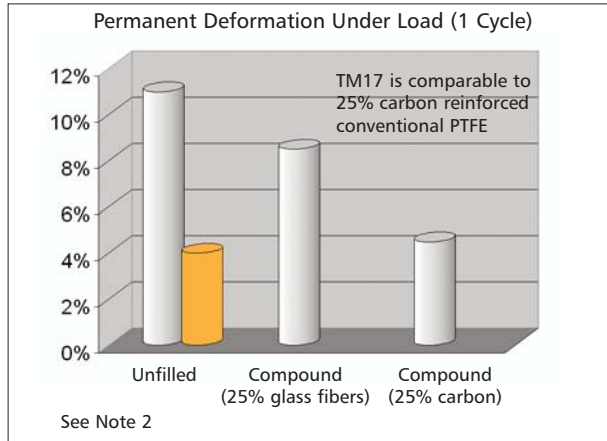
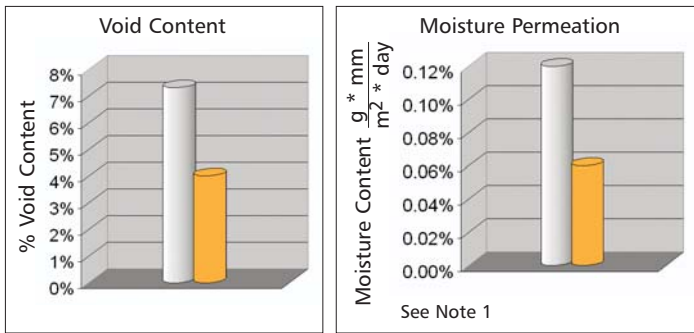

(1) Per ASTM F1249
 (2) Permanent deformation after 100 hours under load. Measured 24 hours after load removal. Based on ASTM D621

■ TM Modified PTFE
 □ Conventional PTFE

Grade 17 EPDM

Grade #17 is comprised of a high molecular weight EPDM elastomer, which provides increased mechanical properties while reducing compression set. In addition, the diaphragm is peroxide cured* enhancing the biocompatibility of the material.

Type: Grade 17

Size Range: BT-6" (DN6 - DN150)

Temperature Rating:

- -4–194°F (-20–90°C) for liquid applications¹
- -22–285°F (-30–140°C) for continuous steam¹
- -22–302°F (-30–150°C) for intermittent steam¹

Pressure Rating:

See Pressure & Temperature chart on page 11

Consult factory for steam rating

Material:

Ethylene Propylene Diene Monomer Peroxide Cured (EPDM)

Regulatory Compliance:

21CFR 177.2600

USP 28 Class VI, Chapter <87>, <88>

Benefits:

- Improved biocompatibility
- Better mechanical properties
- Reduced compression set
- Improved steam resistance (intermittent)

* Peroxide has replaced sulfur as the preferred method of EPDM curing as sulfur was found to be a biocide which could adversely affect sensitive bioprocesses.

¹ For high temperature and/or high cycle applications, contact ITT.

www.ittpureflo.com



Elastomer Diaphragms for Vacuum Service

The standard Pure-Flo diaphragm valve is ideally suited for vacuum service, providing dependable performance and good service life from atmospheric pressure down to nearly full vacuum (-30 in Hg, 0 Bar A) The diaphragm is bi-directional and presents a smooth face with no hidden voids on either side of the valve, whether open, closed or throttling.

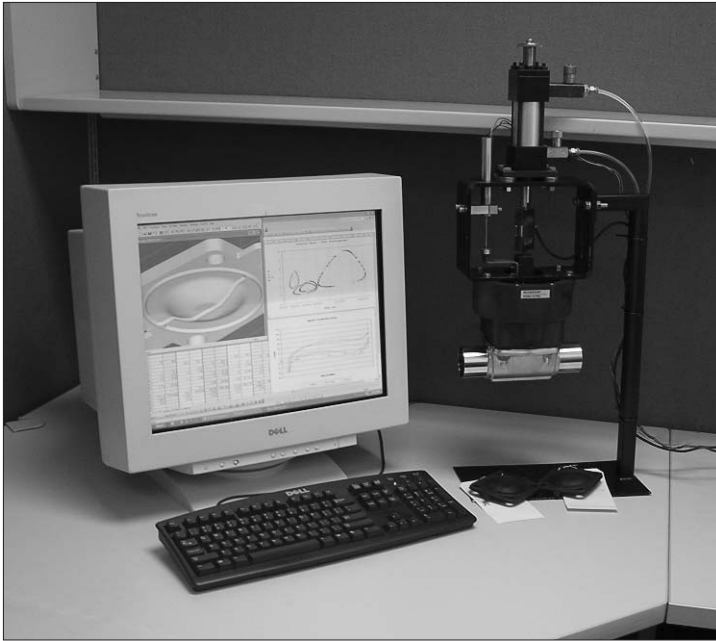

Diaphragm Development

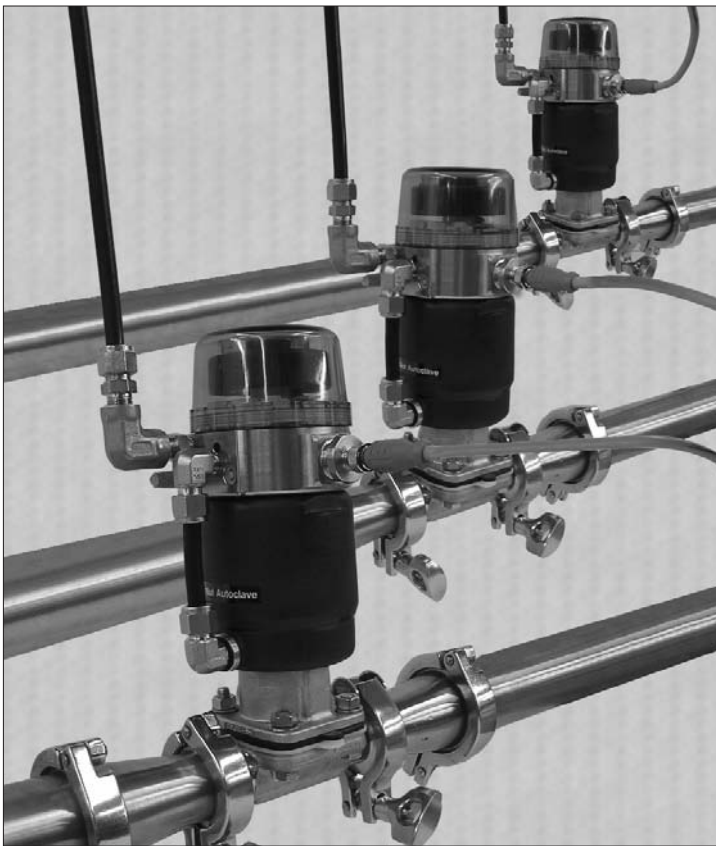

Qualification Testing

Qualification Testing

Quality, performance and reliability of all Pure-Flo diaphragms is assured through extensive testing and comprehensive controls on the diaphragm material manufacturing process. Pure-Flo has years of experience in the development of diaphragm materials for use in the challenging applications within the Pharmaceutical and Bioprocessing industries. This knowledge is applied to each new material development. Successful completion of all appropriate regulatory requirements and operational performance benchmarks must be met before any new diaphragm material is released to the industry.

Typical conformance and performance tests:

- FDA extraction per 21CFR177.2600 (Elastomers)
- FDA extraction per 21CFR177.1550 (PTFE)
- USP28 Class VI Chapters <87> and <88>
- Cycle testing using air, water, and/or steam
- Cycle testing against vacuum and positive pressure at 100% and 0% ΔP conditions
- Cycle testing at ambient and elevated temperatures

Note: ITT Pure-Flo diaphragms are qualified and approved for use with Pure-Flo diaphragm valves. Other makes of diaphragms are not recommended and/or guaranteed by Pure-Flo for use with Pure-Flo valves.

European Pressure Equipment Directive 97/23/EC

Diaphragm valves must comply with European Union Pressure Equipment Directive 97/23/EC. Valves must meet certain Essential Safety Requirements and design criteria. This includes diaphragms as they are an integral component of the valve pressure boundary.

The PED requires the manufacturer to maintain a technical file primarily consisting of:

- Design calculations or proof test
- Material testing
- Performance testing
- Declaration of Compliance to the PED 97/23/EC (available on request)

An excerpt from a guideline for the Pressure Equipment Directive 97/23/EC states:

“Pressure equipment which has been subject to important modifications that change its original characteristics, purpose and/or type after it has been put into service has to be considered as a new product covered by the directive.”¹

Note:

The use of unauthorized and therefore undocumented components within the valve constitutes a major modification to the valve and renders the original ITT Declaration and compliance to the Directive invalid. The end user or the supplier of the unauthorized replacement component must take the responsibility for compliance to 93/23/EC.

¹ http://europa.eu.int/comm/enterprise/pressure_equipment/ped

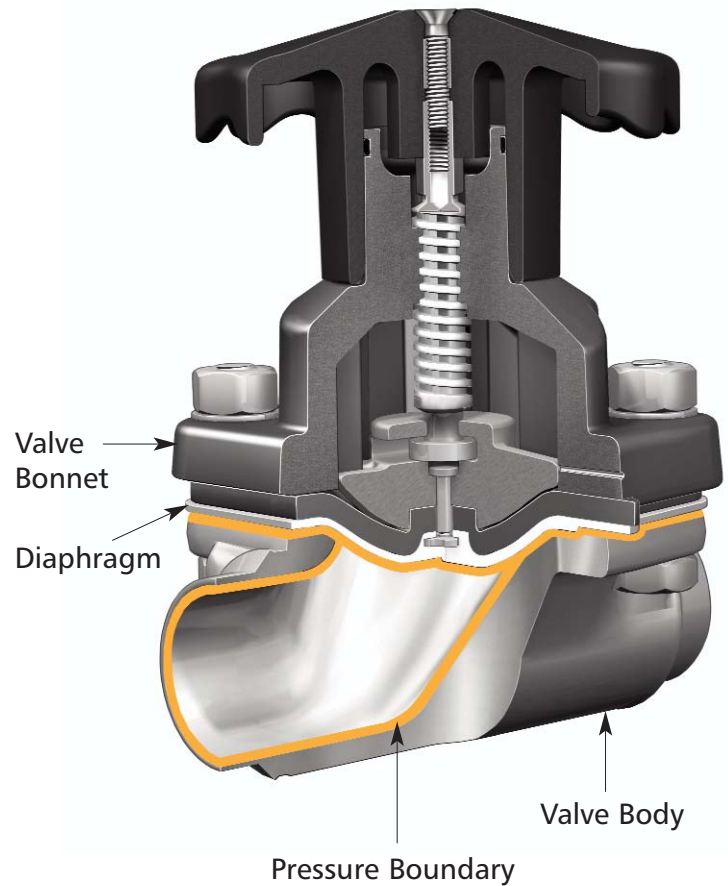

Pressure Boundary

The diaphragm is a critical pressure boundary component of a typical diaphragm valve in conjunction with the valve body, fasteners and manual or actuated bonnet. These components are designed, manufactured and tested to achieve specific pressure ratings and performance criteria. Changes in materials, dimensions or even tolerances of any of these components can have an adverse affect on the overall performance and safety of the valve. ITT Pure Flo conducts extensive testing to support the performance of the valve and pressure boundary.

Pressure/Temperature Recommendations

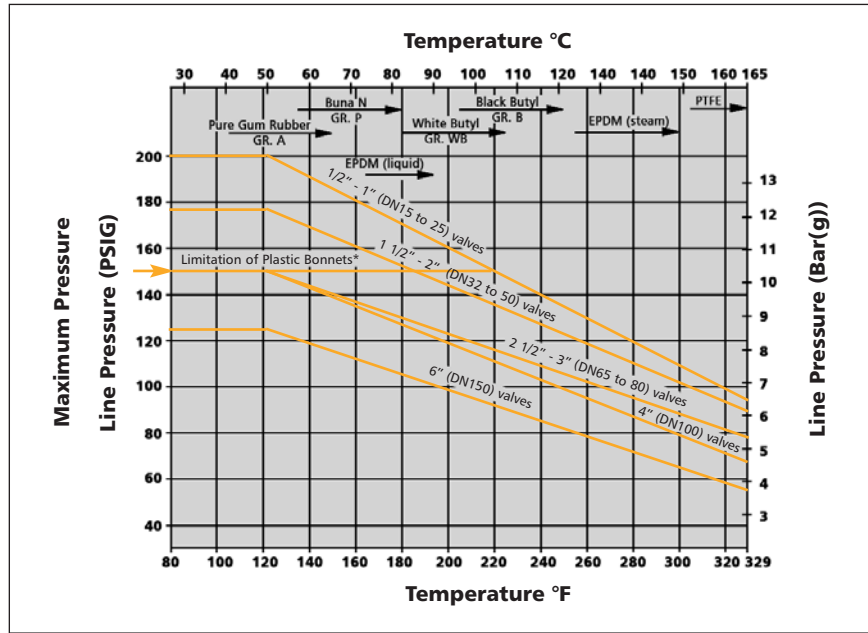

* This line shows the limitation of plastic bonnets including the 963 and Advantage Actuators.

Note: Elastomer diaphragms may be used in vacuum service within above temperature recommendations. For services exceeding charted pressure/temperature recommendations, consult factory. The chart does not pertain to steam or corrosive services. Consult ITT DV-06 Technical Manual and Service Guide for specific recommendations.

PTFE Diaphragms for Vacuum Service

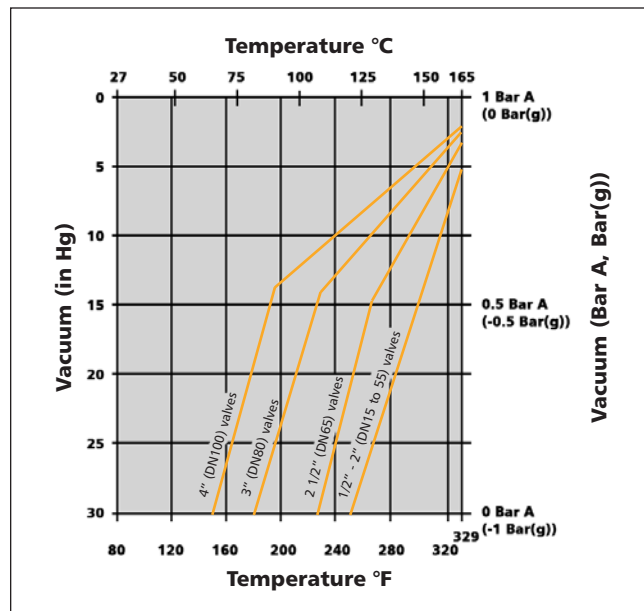

Notes:

1. Service conditions falling to the right of these lines will require bonnet evacuation.
2. PTFE-Diaphragms, 6" (DN 150) size and larger, will not withstand full vacuum at any temperature unless bonnets are evacuated.
3. With evacuated bonnets any size PTFE-Diaphragms can be used up to 329°F (165°C).
4. See page 8 for Elastomer Diaphragms for Vacuum Service

Validation and Compliance

ITT Pure-Flo recognizes the importance of product and process validation to the Pharmaceutical and Bioprocessing industries. A complete selection of documentation is available to facilitate the validation process.

- Diaphragm ingredients and processing aids are FDA compliant
- Physical properties, raw materials, compounding and molding process are documented
- All diaphragms are available with FDA Certificate of Conformance
 - 21CFR177.2600 - Elastomers
 - 21CFR177.1550 - Perfluorocarbon
- All diaphragms are available with USP 28 Class VI Certificate of Conformance
 - Chapter 87 In-Vitro
 - Chapter 88 In-Vivo
- Certificate of Compliance to EMEA/410/01 "Guidance on Minimising the Risk of Transmitting Animal Spongiform Encephalopathy Agents via Human and Veterinary Medicinal Products" available upon request
- Certificate of Traceability to EN 10204 3.1 B available upon request
- Third party testing and in-house performance data available upon request

Note: ITT Pure-Flo diaphragms are qualified and approved for use with Pure-Flo diaphragm valves. Other makes of diaphragms are not recommended and/or guaranteed by Pure-Flo for use with Pure-Flo valves.

Certificates of Compliance

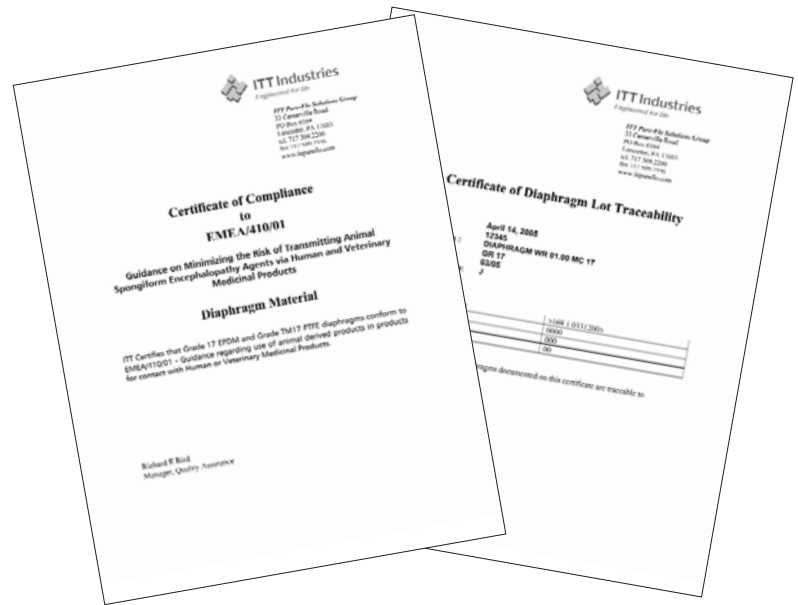

ITT Industries
 Engineered Process Solutions Group
 33 Cartersville Road
 P.O. Box 6164
 Lancaster, PA 17603-2064
 Phone: (800) 366-1111
 Fax: (717) 559-2336

CERTIFICATE OF COMPLIANCE

Date Issued: October 24, 2005

Customer: ABC CORP	Quantity: 100
Customer Order Number: 1000000	
ITT Order Number: 76760	
ITT Line Number: 032	
ITT Item Number: 42175	

Item Number (Description): (A) KIT DIA/BKG CSH BT TM/17
(B) PFC

Additional Information:

- 34851 DIAPHRAGM BT MC TFM GR TM
 Cure Date: 9/05 Quantity: 100
 Grade TM (modified PTFE) diaphragms have a LIMITED SHELF LIFE of 14 years.
 Grade TM (modified PTFE) diaphragms comply with the FDA Code of Federal Regulations Title 21 Section 177-1550 and have been tested in accordance with and successfully passed the U.S. Pharmacopoeia XXVIII Class VI Biological Reactivity test, Section 87 and Section 88.
 The maximum temperature rating for Grade TM (modified PTFE) diaphragms is 350°F/176° C
- 43226 BACKING CUSH BT FDA 17 GR EPDM-17
 Cure Date: 8/05 Quantity: 100
 Grade 17 (EPDM) backing cushions have a LIMITED SHELF LIFE of 6 years.
 Grade 17 (EPDM) backing cushions comply with the FDA Code of Federal Regulations Title 21 Section 177-2000 and have been tested in accordance with and successfully passed the U.S. Pharmacopoeia XXVIII Class VI Biological Reactivity test, Section 87 and Section 88.

Comments:

We certify that the components on the above referenced purchase order meet the requirements of the purchase order, applicable drawing(s), and our ISO 9001:2000 manufacturing, testing, and inspection procedures to assure an acceptable quality level applicable to the product.

/s/ Richard E. Bird

Richard E. Bird
 Manager, Quality Assurance (or representative)
 (This certificate was created electronically and is valid without signature.)

This certificate is correct at the time of issue and no changes shall be made to it without the authorization of the issuing ITT Manager. If any unauthorized changes are made, the certificate is void.

CERTIFICATE ID (203800)

Diaphragm Tab Codes

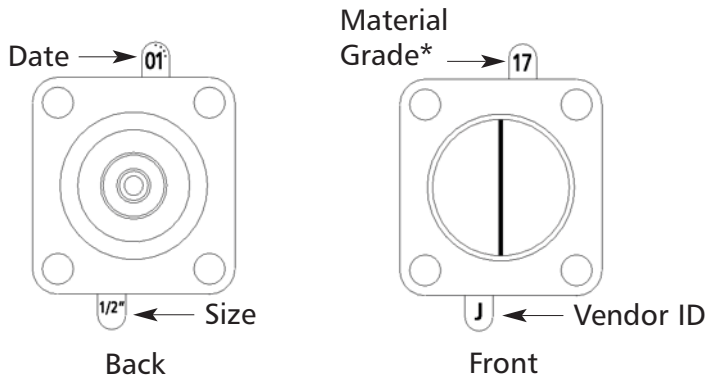

*Hole in tab indicates TM for material grade. Other material grades are listed on page 4.

Elastomer Material Grade Codes

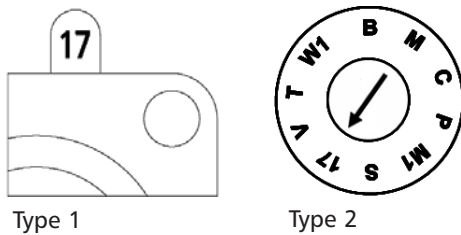

Type 1

Type 2

Elastomer Date Codes

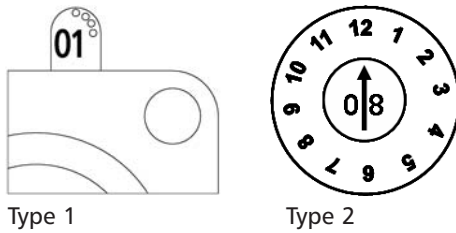

Type 1

Type 2

PTFE Date Codes

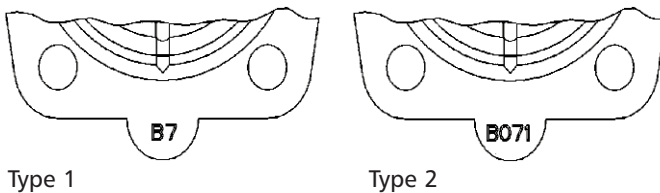

Type 1

Type 2

PTFE Code - Months	
A	January
B	February
C	March
D	April
E	May
F	June
G	July
H	August
I	September
J	October
K	November
L	December

PTFE Code - Year		
Year	4 Digit Code	2 Digit Code
2003	03	3
2004	04	4
2005	05	5
2006	06	6
2007	07	7
2008	08	8
2009	09	9
etc.	etc.	etc.

Diaphragm Traceability

All diaphragm materials and physical properties are batch traceable via permanent codes molded into the diaphragm tabs. The molding date, material grade, and diaphragm size provide traceability to original batch records.

Elastomer Material Grade Codes

Elastomer material grades are listed on page 4 (Type 1). For diaphragms with a clock (Type 2) the arrow points to the material grade.

Elastomer Date Codes

The date is a two digit year code and dots corresponding to months
Type 1: April 2001

For diaphragms with a clock, the two digits in the middle are the year and the arrow points to the month.

Type 2: December 2008

PTFE Date Codes

The first letter identifies the month the lot was manufactured. For a two digit code, the second digit is the year (Type 1: B7 = February 2007). For a four digit code, the next two digits indicate the year, and the last number indicates the batch number (Type 2: B071 = February 2007, batch 1).

Packaging

All Pure-Flo diaphragms are sealed in individual tamper evident packages to prevent damage and contamination during transportation, handling and storage.

Tamper evident packaging provides an extra level of assurance that the diaphragm has not been exposed to potential contamination during storage or maintenance activities prior to installation.

All Pure-Flo Diaphragm packages contain important information necessary for validation and maintenance.

- Diaphragm part number
- Description
- Material
- Pack date
- Cure date
- Installation graphic

Storage Recommendations

- Storage temperature should be between 40-75°F (5-25°C). Higher temperatures may affect overall service.
- Diaphragms should be stored in a cool dry environment so that condensation does not occur.
- Diaphragms should be protected from direct sunlight and Ultra Violet light sources.
- Where possible diaphragms should be protected from circulating air. Storage in bags or other air tight containers is recommended for longest service life.
- Physical properties and performance of rubber diaphragms can deteriorate when stored for long periods. The diaphragm may become unsuitable for service due to environmental, physical, and chemical factors.



Packaging Method of US based Pure-Flo Sites



European Market Packaging

Shelf Life

Material	Grade	Shelf Life
Butyl	B, W1	10
EPDM	17	6
Buna N	P	6
PTFE ¹	TM17	10

1 PTFE diaphragm face only.

Cleaning

	Sodium Hydroxide NaOH	Sodium Hypochlorite NaOCl	Potassium Hydroxide KOH	Phosphoric Acid H ₃ PO ₄	Hydrogen Peroxide H ₂ O ₂
PTFE	R	R	R	R	R
EPDM	R	R	R	R	R
Butyl	R	R	R	R	U
Silicone	R	R	U	U	R

Consult factory for specific temperature and concentration limitations.

Sterilization

	Saturated Steam ¹			Dry Heat ²	Ozone ³
	20 psi 1.4 Bar(g)	30 psi 2.1 Bar(g)	40 psi 2.8 Bar(g)		
PTFE	R	R	R	R	R
EPDM	R*	R*	R*	U	R
Butyl	R*	R*	R*	U	R
Silicone	U	U	U	U	R

¹ 20psi/1.4 Bar(g) = 259°F/126°C

30psi/2.1 Bar(g) = 274°F/135°C

40psi/2.8 Bar(g) = 286°F/142°C

² 338°F/170°C

³ 3% at 80°F/27°C

* Limited life and undesirable failure mode

Passivation

	Nitric Acid 15% ¹	Phosphoric 10% ¹	Citric Acid 15% ¹	Mixed Chelants ²
PTFE	R	R	R	R
EPDM	U	R	R	R
Butyl	R	R	R	R
Silicone	U	U	R	R

¹ At 60°C/140°F

² Amonium citrate Base at 80°C/176°F

R = Resistant

U = Unsatisfactory

Application

Pure-Flo diaphragms are suitable for a wide range of utility and process applications utilized in the Pharmaceutical and Biotech industries. However, not all diaphragm materials are suitable for all processes and conditions. The accompanying tables should be used as a reference.

The worldwide network of ITT Pure-Flo technical resources are available to assist in determining the proper diaphragm for your application.

Typical Process Applications:

- WFI
- Purified water
- Product solutions
- Buffer solutions
- Cell culture solutions
- Media
- Solvents
- Protein solutions
- Ultra filtration

Typical Utility Applications:

- Passivation protocols
- Cleaning protocols
- Sterilization protocols

For more information, please contact:

Pure-Flo Headquarters

33 Centerville Road
Lancaster, PA 17603-2064 USA
Phone +1 (800) 787-3561
Phone +1 (717) 509-2200
Fax +1 (800) 239-9402

Website: www.ittpureflo.com

E-mail: pureflo.custserv@itt.com

Valve Office Locations:

Pure-Flo

110-B West Cochran
Simi Valley, CA 93065 USA
Phone +1 (800) 926-8884
Phone +1 (805) 520-7200
Fax +1 (805) 520-7205

Pure-Flo

Richards Street
Kirkham, Lancashire
PR4 2HU, England
Phone +44-1772-682696
Fax +44-1772-686006

